



Panasonic Omnivision **VHS**

Combination VCR Operating Instructions

Models **PV-M939/PV-M949W**

Basic Operation



Advanced Operation

As an **ENERGY STAR**® Partner, Matsushita Electric Corporation of America has determined that this product or product model meets the **ENERGY STAR**® guidelines for energy efficiency.



Please read these instructions carefully before attempting to connect, operate or adjust this product. Please save this manual.

Spanish Quick Use Guide is included. (Guía para rápida consulta en español está incluida.)

For assistance, call 1-800-211-PANA(7262)

For Your Information

Important Safeguards and Precautions

READ AND RETAIN ALL SAFETY AND OPERATING INSTRUCTIONS. HEED ALL WARNINGS IN MANUAL AND ON UNIT

INSTALLATION

1 POWER SOURCE CAUTION

Operate only from power source indicated on unit or in this manual. If uncertain, have an Electric Utility Service Company or Video Products Dealer verify your home power source.

2 POWER CORD PLUG

For safety, this unit comes with a polarized type plug (one wide blade), or a three-wire grounding type plug.

POLARIZED PLUG CAUTION:

The plug fits into outlet one way. If it cannot be fully inserted, try reversing it. If it still will not fit, have an electrician install the proper wall outlet. Do not tamper with the plug.

GROUNDING PLUG CAUTION:

The plug requires a three-hole grounding outlet. If necessary, have an electrician install the proper outlet. Do not tamper with the plug.

3 POWER CORD

Make sure power cords are routed so they are not likely to have anything rest on them, roll over them, or be in the way of walking traffic. An extension cord should have the same type plug (polarized or grounding) and must be securely connected. Overloading wall outlets or extension cords may cause fire hazard. Frayed cords, damaged plugs, and damaged or cracked wire insulation are hazardous and should be replaced by a qualified electrician.

4 DO NOT BLOCK VENTILATION HOLES

Ventilation openings in the cabinet release heat generated during operation. If blocked, heat build-up may result in a fire hazard or heat damage to cassettes.

For your protection:

- Never cover ventilation slots while unit is ON, or operate unit while placed on a bed, sofa, rug, or other soft surface.
- Avoid built-in installation, such as a book case or rack, unless properly ventilated.

5 AVOID EXTREMELY HOT LOCATIONS OR SUDDEN TEMPERATURE CHANGES

Do not place unit over or near a heater or regulator, in direct sunlight, etc. If unit is suddenly moved from a cold place to a warm place, moisture may condense in unit and on the tape causing damage.

6 TO AVOID PERSONAL INJURY

- Never place unit on support or stand that is not firm, level, and adequately strong. The unit could fall causing serious injury to a child or adult and damage to the unit.
- Move any appliance and cart combination with care. Quick stops, excessive force, and uneven surfaces may cause objects to overturn.
- Carefully follow all operating instructions.



OUTDOOR ANTENNA INSTALLATION

1 SAFE ANTENNA AND CABLE CONNECTION

An outside antenna or cable system must be properly grounded to provide some protection against built up static charges and voltage.

Section 810 of the National Electrical Code, ANSI/NFPA 70 (in Canada, part 1 of the Canadian Electrical Code) provides information regarding proper grounding of the mast and supporting structure, grounding of the lead-in wire to an antenna discharge unit, size of grounding conductors, location of antenna discharge unit,

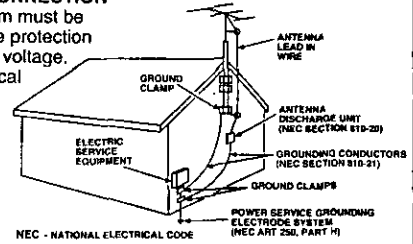

connection to grounding electrodes, and requirements for the grounding electrode.

2 KEEP ANTENNA CLEAR OF HIGH VOLTAGE POWER LINES OR CIRCUITS

Locate an outside antenna system well away from power lines and electric light or power circuits so it will never touch these power sources should it ever fall. When installing antenna, absolutely never touch power lines, circuits or other power sources as this could be fatal.

USING THE VIDEO UNIT

Before unit is brought out of storage or moved to a new location, refer again to the INSTALLATION section of these safeguards.

1 KEEP UNIT WELL AWAY FROM WATER OR MOISTURE, such as a kitchen sink, bath tub, pool, and so on.

2 IF EXPOSED TO RAIN, MOISTURE, OR STRONG IMPACT, unplug unit and have it inspected by a qualified service technician before use.

3 ELECTRICAL STORMS

During a lightning storm, or before leaving unit unused for extended periods of time, disconnect all equipment from the power source as well as the antenna and cable system.

4 WHEN UNIT IS PLUGGED IN

- Never expose to rain or water. DO NOT OPERATE if liquid has been spilled into unit. Immediately unplug unit, and have it inspected by a service technician. Fire and shock hazards can result from electrical shorts caused by liquid contact inside.
- Never drop or push any object through openings in unit. Some internal parts carry hazardous voltages and contact can cause electric shock or fire hazard.
- Avoid placing unit directly on top or underneath a TV as this may cause electrical interference. Keep all magnets away from electronic equipment.

5 USING ACCESSORIES

Use only accessories recommended by the manufacturer to avoid risk of fire, shock, or other hazards.

6 CLEANING UNIT

Unplug unit. Use a clean, dry, chemically untreated cloth to gently remove dust or debris. DO NOT USE cleaning fluids, aerosols, or forced air that could over-spray, or seep into unit and cause electrical shock. Any substance, such as wax, adhesive tape, etc. may mar the cabinet surface. Exposure to greasy, humid, or dusty areas may adversely affect internal parts.

SERVICE

1 DO NOT SERVICE PRODUCT YOURSELF

If, after carefully following detailed operating instructions, the unit does not operate properly, do not attempt to open or remove covers, or make any adjustments not described in the manual. Unplug unit and contact a qualified service technician.

2 REPLACEMENT OF PARTS

Make sure the service technician uses only parts specified by the manufacturer, or have equal safety characteristics as original parts. The use of unauthorized substitutes may result in fire, electric shock, or other hazards.

3 SAFETY CHECK AFTER SERVICING

After unit is serviced or repaired, request that a thorough safety check be done as described in the manufacturer's service literature to insure video unit is in safe operating condition.

Safety Precautions

Warning: To prevent fire or shock hazard, do not expose this equipment to rain or moisture.

This video recorder, equipped with the HQ (High Quality) System, is compatible with existing VHS equipment.

Only use those tapes with the **VHS** mark. It is recommended that only cassette tapes that have been tested and inspected for use in 2, 4, 6, and 8 hour VCR machines be used.

This television receiver provides display of television closed captioning in accordance with §15.119 of the FCC rules.

FCC WARNING: Any unauthorized changes or modifications to this equipment would void the user's authority to operate.

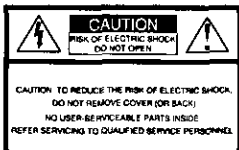

This symbol warns the user that uninsulated voltage within the unit may have sufficient magnitude to cause electric shock. Therefore, it is dangerous to make any kind of contact with any inside part of this unit.

This symbol alerts the user that important literature concerning the operation and maintenance of this unit has been included.

Therefore, it should be read carefully in order to avoid any problems.

Table of Contents

Use
Now!

Important Safeguards and Precautions	2
Before Using	4, 5
• Accessories	4
• Loading the Batteries	4
• Prevent Accidental Tape Erasure	4
• Reset all Combination VCR Memory Functions	5
• Head Cleaning	5
• Record/Playback Time	5
• DST (Daylight Saving Time)	5
• Specifications	5
Connections (Outdoor/Indoor Antenna and DSS/Cable Box connections, Connecting to a Power Source)	6, 7
One Time Setup (Language, Channel, Clock)	8, 9
TV Operation (NITE mode, Using the 100 key, Rapid Tune, Audio Mute, Phones, SELF-DEMO mode)	10
Picture Adjustment	11
Playback a Tape (Slow Motion, Still Picture, Frame by Frame, Features for Quality) ..	12
Record On a Tape	13
• One Touch Recording	13
• Selecting Input Mode	13

Enjoy
More!

Timer Recording	14, 15
• Timer Recording Using Combination VCR Buttons	14
• Review, Replace or Clear Program Contents	15
TV Timer Features	16, 17
• ON-TIMER with Alarm	16
• SLEEP TIMER	16
• INSTANT ALARM	17
Closed Caption System	18, 19
• Closed Caption Mode Feature	18
• Caption on Mute Feature	19
FM Radio	20, 21
Tape Operation	22 ~ 25
• Tape Position Display	22
• Zero Search	22
• Repeat Play	23
• Auto Operation Functions	23
• One Minute Skip	23
• VHS Index Search System ..	24, 25
Special VCR Features	26 ~ 30
• Channel Caption	26, 27
• Time Stamp	28, 29
• Weak Signal Display ON/OFF ..	30
• VCR Lock	30
Copying Your Tapes (Dubbing)	31
V-Chip Control Feature	32 ~ 35
• Enter or Change Secret Code	32
• Setup TV PARENTAL Ratings ..	34
• Blocking Message	35
• Setup MOTION PICT. Ratings	33

Other
Information!

Reset Language, Channels, Clock	36, 37
On-Screen Display (OSD)	38
• VCR Status & Clock Display	38
• Channel & Function Display	38
• Warning and Instruction Displays	38
• Dew Detection System	38
Operation Differences Using AC or DC Power	39
Before Requesting Service	40
Service Center List	41
Spanish (Español) Quick Use Guide	42 ~ 45
Location of Controls	46, 47
Warranty	Back Cover

Basic Operation

Advanced Operation

For Your Information

Before Using

Congratulations

on your purchase of one of the most sophisticated and reliable products on the market today. Used properly, it will bring you and your family years of enjoyment. Please fill in the information below. The serial number is on the tag located on the back of your Combination VCR.

Date of Purchase _____
 Dealer Purchased From _____
 Dealer Address _____
 Dealer Phone No. _____
 Model No. _____
 Serial No. _____

Accessories

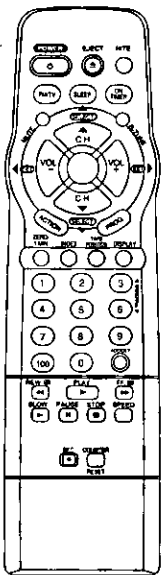

- Remote Control
 VSQS1602(PV-M939)
 VSQS1605(PV-M949W)

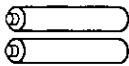

- Batteries
 2 "AA"

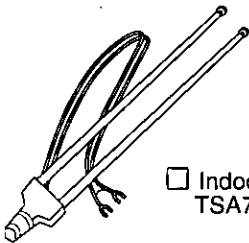

- Indoor Antenna
 TSA700009



- 300 ohm-75 ohm
 Transformer
 VSQS0974

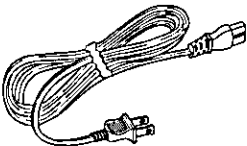

- AC Power Cord
 VJAW0044(PV-M939)
 LFX6109A(PV-M949W)

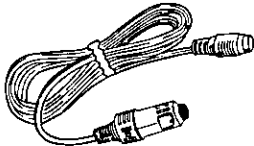

- DC Car Cord (2m)
 LFX6301A

For model PV-M949W only

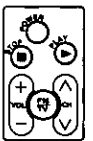

- Kitchen (Easy-Find™) Remote Control
 (VSQS1572) with one CR2025 Battery
- The Kitchen remote control has been loaded with battery.

To order accessories,
 call toll free 1-800-332-5368.

Loading the Batteries

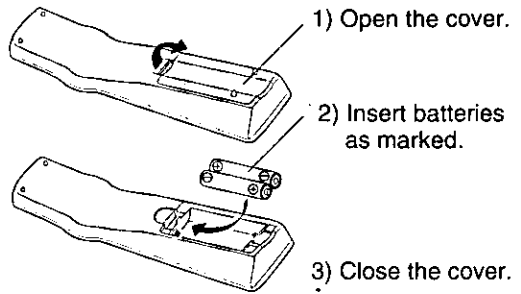

Battery replacement caution

- Do not mix old and new batteries.
- Do not mix alkaline with manganese batteries.

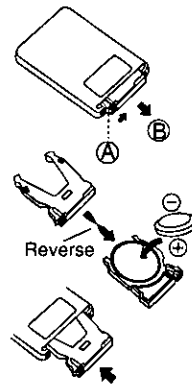

Kitchen (Easy-Find™) Remote Control <For model PV-M949W only>

- 1) (A) While pressing the stopper tab, (B) pull the Battery Tray out.
- 2) Insert the battery into the Battery Tray with the ⊕ mark facing down. Do not reverse the polarity.
- 3) Replace the Battery Tray.

Replace battery with Panasonic PART NO. VSBW0004 (CR2025) only. Use of another battery may present a risk of fire or explosion. Caution-battery may explode if mistreated. Dispose of used battery promptly. Keep away from children. Do not recharge, disassemble or dispose of in fire.

Prevent Accidental Tape Erasure

Break off the tab.

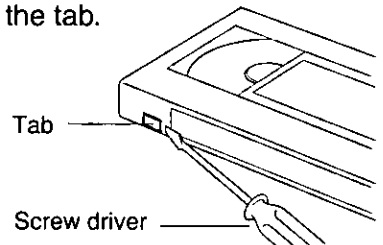

To record again.

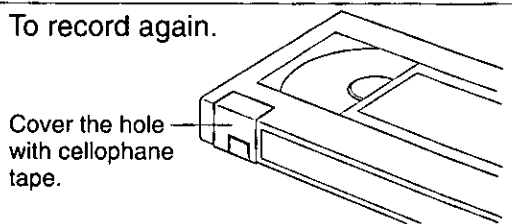

Reset all Combination VCR Memory Functions

Use when moving Combination VCR to new location, or if a mistake was made in the One Time Setup section.

- Make sure a tape is not inserted in the Combination VCR.

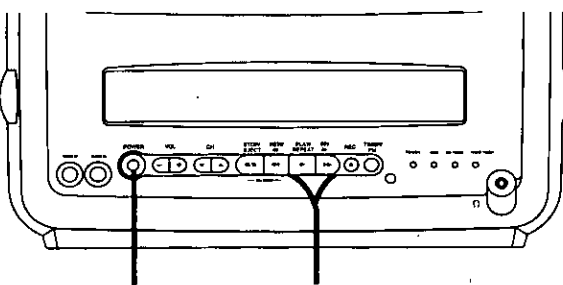

- 1 Turn the Combination VCR Power on.
- 2 Press and hold both the PLAY and FF on the Combination VCR for more than 5 seconds.
 - The power will shut off.
- 3 Do One Time Setup Steps on page 8.

Head Cleaning

Playing older or damaged tapes may eventually cause video heads to become clogged.

Head Clog Sensor
During playback this screen appears if clogging is detected. To remove screen, press PLAY on the remote or Combination VCR.

- Use "dry" type head cleaning cassette only. (Part No. NV-TCL30PT is recommended.)
- Follow cleaning tape carefully. Excessive use of tape can shorten head life.
- If head clog symptoms persist, contact your nearest Factory Service Center or authorized Service Center. (See page 41.)

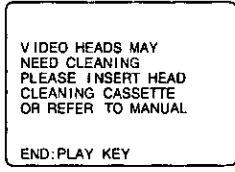

Record/Playback Time

Only use tapes with the **VHS** mark in this unit.

Tape Speed Setting	Type of Video Cassette		
	T60	T120	T160
SP (Standard Play)	1 Hour	2 Hours	2 Hours 40 minutes
LP (Long Play)	2 Hours	4 Hours	5 Hours 20 minutes
SLP (Super Long Play)	3 Hours	6 Hours	8 Hours

DST (Daylight Saving Time)

Combination VCR auto adjusts clock for DST (Daylight Saving Time.)

Spring (First Sunday in April)

DST:ON → Sets clock ahead one hour.

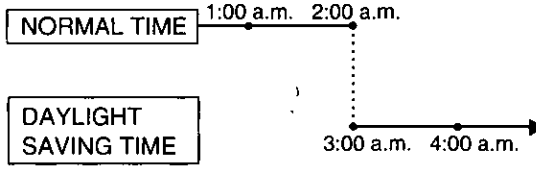

Autumn (Last Sunday in October)

DST:ON → Turns clock back one hour.

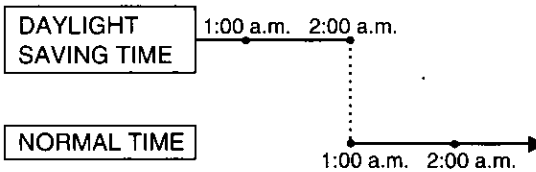

- If your area does not observe Daylight Saving Time, select DST: OFF.
- Keep these time changes in mind when programming the Combination VCR for timer recordings.

Specifications

- Display**
Picture Tube: 9 inch measured diagonal 90° deflection Picture Tube
- VCR**
Video Recording System: 2 rotary heads helical scanning system
Audio Track: 1 track
Tuner:
Broadcast Channels: VHF 2-13, UHF 14-69
CABLE Channels: Midband A through I (14-22) Superband J through W (23-36) Hyperband AA-EEE (37-64) Lowband A-5-A-1 (95-99) Special CABLE channel 5A (01) Ultraband 65-94, 100-125
- FM Radio**
Band range: 87.5~108.1 MHz
- General**
Power Source: 120V AC, 60 Hz (AC) 12V/24V (DC)
Power Consumption: Power on
Approx. 64 watts (AC)
Approx. 59 watts (DC)
Power off
Approx. 3.5 watts (AC)
Approx. 0.8 watts (DC 12V)
Approx. 1.5 watts (DC 24V)
EIA Standard NTSC color 1 piece
- Television System:
Speaker:
Operating Temperature: 41°F~104°F (5°C~40°C)
Operating Humidity: 10%~75%
Weight: 20.1 lbs. (9.1 Kg)
Dimensions: 11-7/8" (W) X 12-7/8" (H) X 13-3/16" (D) 302 (W) X 327 (H) X 335 (D) mm

Note: Designs and specifications are subject to change without notice.

Outdoor Antenna Connections

Unhook the antenna from your previous TV or VCR and connect it to the back of the Combination VCR as shown in the diagram.

If your antenna system has separate UHF and VHF lead-ins, you need a UHF/VHF Band Mixer (not supplied.)

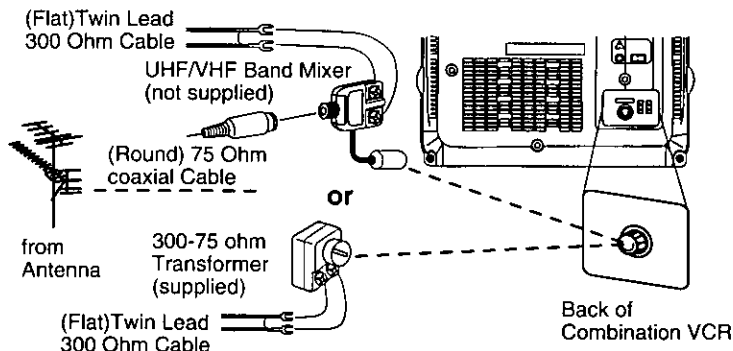

DSS/Cable box Connections

■ Without a Cable Box

You can;

- record or view unscrambled channels.

You cannot;

- record or view scrambled channels.
- view a channel other than the one selected for any type of recording.

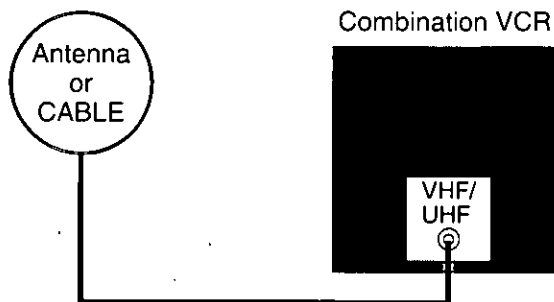

■ With a Cable Box

You can;

- record or view any channel including scrambled channels.

NOTE: Channel selection must be made at the cable box.

You cannot;

- view a channel other than the one selected for any type of recording.
- do a Timer recording of a channel unless you select it at the cable box.

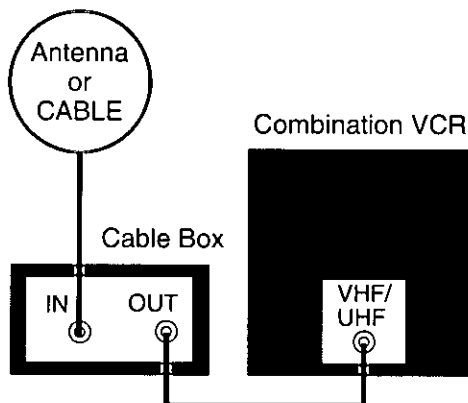

Note to CABLE System installer

This reminder is provided to call the CABLE (Cable TV) System Installers attention to Article 820-40 of the NEC that provides guidelines for proper grounding and, in particular, specifies that the cable ground shall be connected to the grounding system of the building, as close to the point of cable entry as practical.

■ With a DSS Receiver

You can;

- record or view any channel including scrambled channels.

NOTE: Channel selection must be made at the DSS Receiver.

You cannot;

- view a channel other than the one selected for any type of recording.
- do a Timer recording of a channel unless you select it at the DSS box.

NOTE: The DSS receiver must be turned off to view programs from a cable box or antenna. See the DSS manual for details.

*DSS® is registered trademark of DIRECTV, INC., a unit of GM Hughs Electronics.

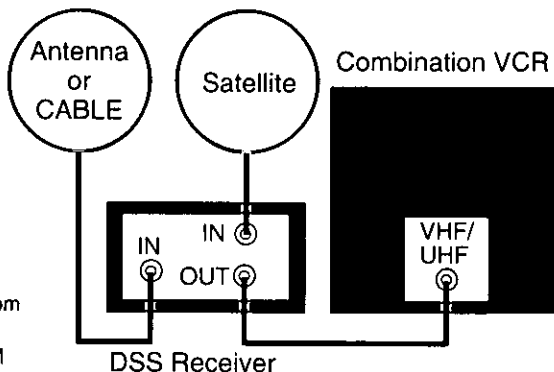

Indoor Antenna Connections

Insert the Indoor antenna (supplied) into the receptacle on the back of the Combination VCR. Then, connect the two wires to the 300 ohm-75 ohm transformer (supplied.) Next, connect the transformer to the back of the Combination VCR as shown. Now, extend the antenna and adjust its length, direction and angle for the clearest picture.

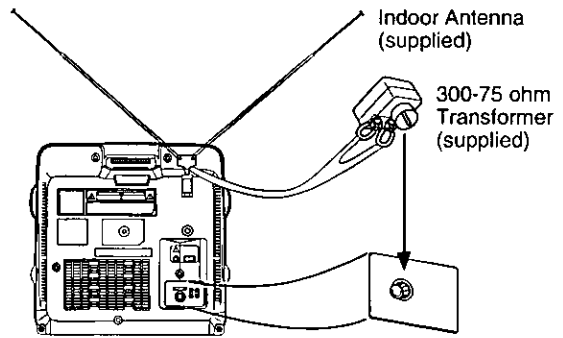

Connecting to a Power Source

Your Combination VCR goes where you go with two different ways to supply power. You may connect the supplied AC (alternate current) cord for use with any AC outlet. Or when travelling, connect the supplied DC (direct current) Car Battery cord which can be inserted in your vehicle's cigarette lighter. For your safety and to avoid damage to the Combination VCR, please follow instructions and connections carefully.

■ Connecting the (supplied) AC Cord

1. Connect the supplied AC cord to the AC input jack on the back of the Combination VCR as shown.
2. Plug the AC cord into an AC wall outlet.

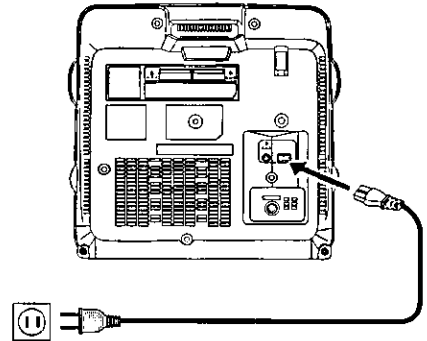

■ Connecting the (supplied) DC Cord

1. Connect the DC Car Battery cord to the DC input on the back of the Combination VCR as shown.
2. Start the engine of your vehicle.
 - **DO NOT** insert the cord into the cigarette lighter until the engine is running.
3. Remove the cigarette lighter from its socket and insert the Car Battery plug in its place.

IMPORTANT NOTES

- This cord can only be used in vehicles equipped with DC 12V or 24V (negative ground) batteries. Check your car's owner's manual.
- Use the only the Car Battery cord packed with your Combination VCR.
- To avoid a loss voltage, do not attach an extension to the Car Battery cord.
- When unit is not in use, disconnect the Car Battery cord from the cigarette lighter socket to save car battery.

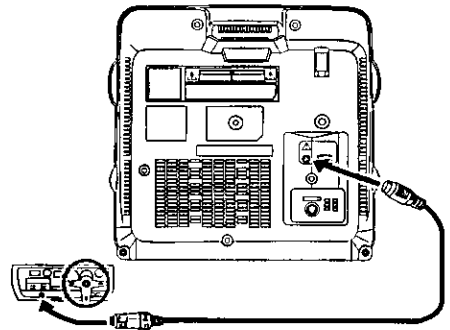

■ Replacing the DC Car Cord Fuse

If the safety fuse in the car cord plug blows out, replace it as follows.

1. Unscrew the cap (counterclockwise.)
2. Replace using a 125V 10A fuse.
 - Only use fuses with the exact voltage and amps specified.
3. Replace the cap (clockwise.)

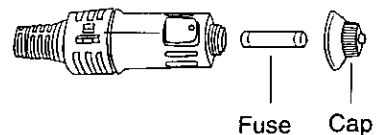

One Time Setup

When the Combination VCR is turned on the first time, setup mode is entered automatically.



Process of Setup

Language → Channel → Clock

1  **Press POWER on the Combination VCR.**

2 **SELECT LANGUAGE**
 PUSH CH ▲ : English
 OPRIMIR CH ▼ : Español
 APP. VOL + : Français

Select the language.

 for English
 for Spanish (Español)
 for French (Français)

- If wrong language is set, do "Reset all Combination VCR Memory Functions" steps page 5.
- If you use a cable box, the cable box must be left on.

3 **CHANNEL/CLOCK AUTO SET**
 CONNECT ANTENNA CABLE AND IF YOU USE A CABLE BOX, TUNE IT TO YOUR LOCAL PBS CH THEN...
 PLEASE PUSH CH UP KEY

Start Channel Auto Set and Clock Auto Set.

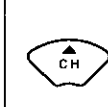
 Press CH ▲.

CH AUTO SET PROCEEDING

AUTO CLOCK SET PROCEEDING

Case 1
 (Setup completed)

7/28/1999 WED 12:00PM
 DST:ON
 SETTING : CH 10
 AUTO CLOCK SET COMPLETED
 END : PUSH CH UP KEY

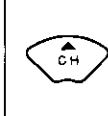
 Press CH ▲ to exit.

- If your area observes daylight saving time, but you would like to turn the DST feature off, do the Reset Clock steps on page 37 and set DST:OFF.

- If your area observes daylight saving time and DST is set to ON, but the time is incorrect; do the Time Zone Adjust steps on the next page.

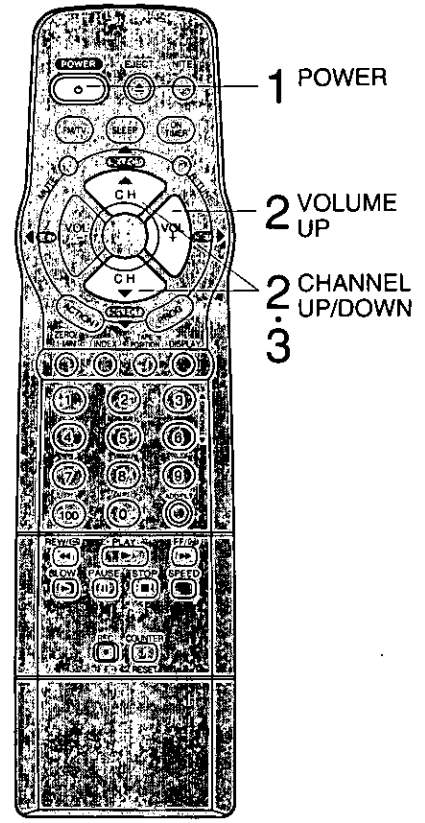

Case 2
 (Setup incomplete)

AUTO CLOCK SET IS INCOMPLETE
 PUSH ACTION TO SET CLOCK

See Case 2 next page.

IMPORTANT NOTE FOR AUTO CLOCK SET

- Auto clock set is performed the first time when Combination VCR is turned off each day. If used, a cable box must be left on and tuned to the PBS channel at the time Combination VCR power is turned off if you want auto clock set to be done.
- If used, a DSS receiver, it must be turned off for auto clock set.
- If Cable Box or DSS receiver is connected to Combination VCR via Audio/Video Jacks, an RF coaxial cable must also be connected for auto clock set and channel auto set features.
- If for any reason the time is changed manually, automatic time correction will not occur.

Case 1 Set TIME ZONE ADJUST.

1  **Display MAIN MENU.**
Press ACTION.

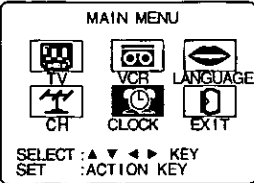
2  **Display SET CLOCK screen.**
1) Press ▲▼◀▶ to select "CLOCK."
2) Press ACTION to display.

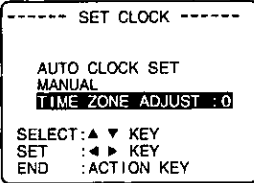
3  **Select TIME ZONE ADJUST.**
1) Press ▲▼ to select.
2) Press ◀▶ to subtract or add hour(s) as necessary.

4  **End setup.**
Press ACTION twice.
• TIME ZONE ADJUST returns to "0" if clock is set manually.

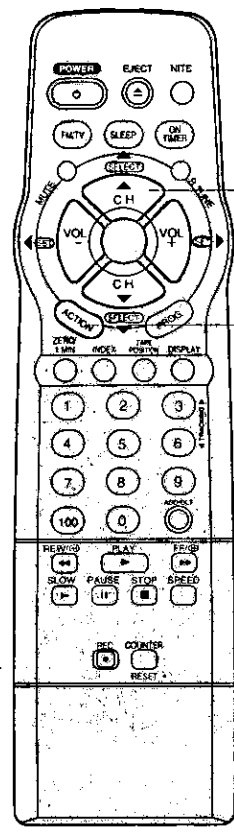

2. SELECT/SET
3. ▲:CH UP
▼:CH DOWN
▶:VOL UP
◀:VOL DOWN
1. ACTION
2. 4. a. c

Case 2 Clock Setup is Incomplete. Set the clock manually.

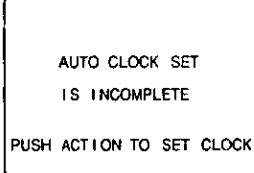
a  **Display SET CLOCK screen.**
Press ACTION to exit this mode.

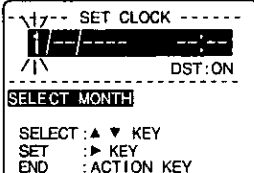
b  **Set the clock manually.**
1) Press ▲▼ to select the month.
2) Press ▶ to set.

• Likewise set date, year, time, and DST (Daylight Saving Time.)

To Make Corrections, repeatedly press ◀▶ to move to error, then correct.

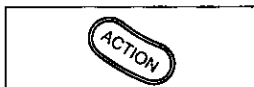
c  **End setup.**
Press ACTION twice (Clock starts.)

Notes

- This Combination VCR calendar is accurately maintained its calendar up to Dec. 31, 2089, 11:59PM.
- Channel auto set selects normal TV or Cable channels depending on your Combination VCR hookup.

Using ▲▼◀▶ keys

 On Remote

- ▲:CH UP
- ▼:CH DOWN
- ▶:VOLUME UP
- ◀:VOLUME DOWN

Whenever the menu or program screen is displayed, CHANNEL UP/DOWN and VOLUME UP/DOWN function as ▲▼◀▶ only.

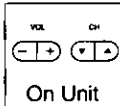
 On Unit

ACTION key on the unit

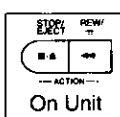
 On Unit

You can operate the menu screen using unit buttons. To display the menu, press STOP/EJECT and REW together with no tape inserted. To exit the menu, repeat above with or without tape inserted.

TV Operation

1



Press **POWER** on the Combination VCR.

Check list before you begin.

- All connections are made (see page 6.)
- Your Combination VCR is plugged in.

2

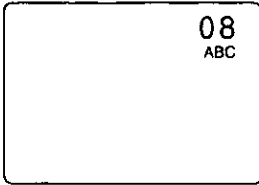

Select a channel.

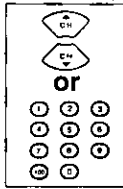

Using **CH ▲▼** or **NUMBERED** keys.

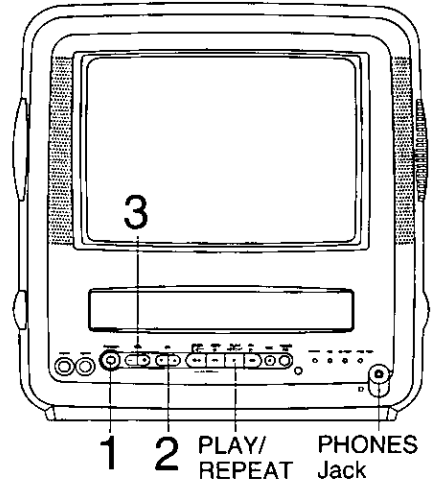

1 2 **PLAY/REPEAT** **PHONES Jack**

3

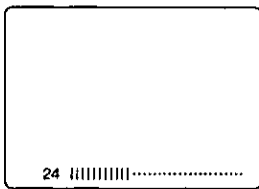

Adjust volume.

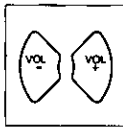

Press **VOL+ -**.

NITE Mode

Color and picture intensity levels are adjusted so the screen is easier on your eyes during night time use.

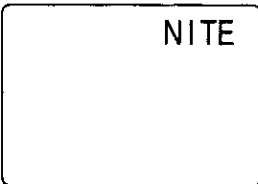

Set **NITE mode**.

Press **NITE**.

- NITE mode may be selected when watching TV, playing a tape, or while in FM mode.

To **Cancel**, press **NITE**.

- Previous settings are restored.
- NITE mode is cancelled when power is turned off or power failure occurs.

Using the 100 key

When selecting **CABLE** channels 100 to 125 with the **NUMBERED** keys, first press the **100** key, and then enter the remaining two digits.

Rapid Tune

Press **R-TUNE** to display the last channel you were watching.

Audio Mute

Press **MUTE** to instantly mute the sound. Press again, to restore the previous sound level.

Phones

Connect an earphone (not supplied) or headphones (not supplied) to the **Phones Jack**.

SELF-DEMO Mode

With **Power ON**, hold down **PLAY/REPEAT** on the Combination VCR for 5 seconds to display demo screen. Repeat this to exit.

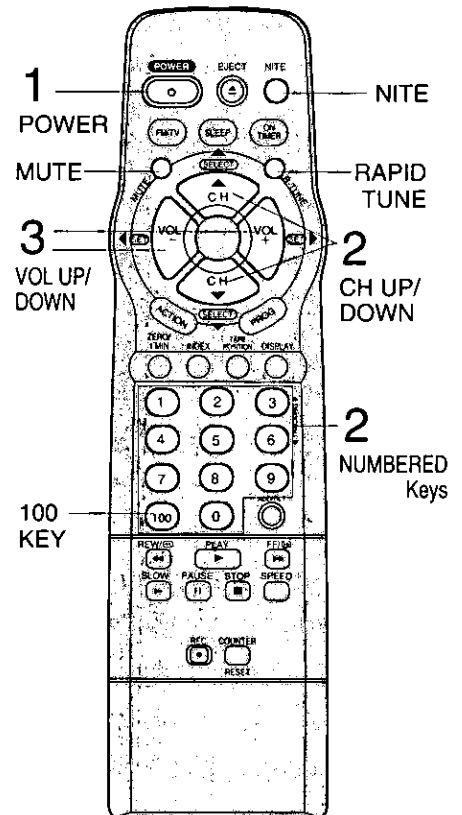

1 **POWER** **NITE**
MUTE **RAPID TUNE**
3 VOL UP/DOWN **2 CH UP/DOWN**
2 NUMBERED Keys
100 KEY

10

For assistance, call 1-800-211-PANA(7262)

Picture Adjustment

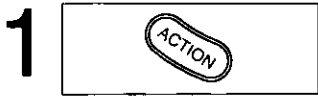

1 Display MAIN MENU.
Press ACTION.

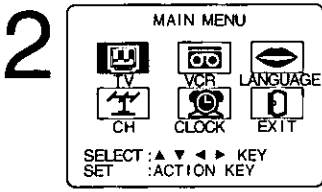

2 Display SET UP TV screen.
1) Press ▲▼◀▶ to select "TV."
2) Press ACTION to display.

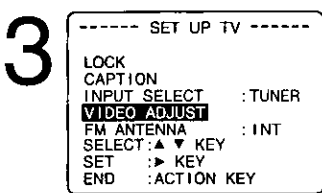
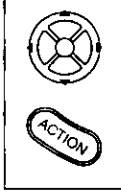

3 Display VIDEO ADJUST screen.
1) Press ▲▼ to select.
2) Press ▶ to display.

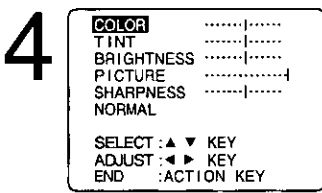
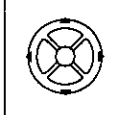

4 Adjust desired item.
1) Press ▲▼ to select on item.
(See below right.)
2) Press ◀▶ to adjust.

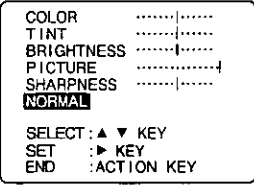
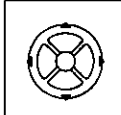

To Reset Picture Controls
Press ▲▼ and ▶ to select and set "NORMAL."
All controls return to their factory settings.



5 End setup.
Press ACTION three times to exit.

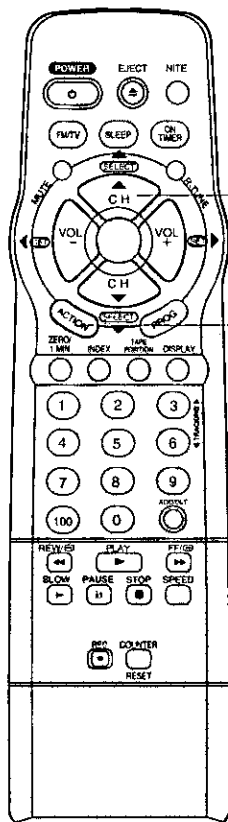

- 2 SELECT/SET
- 3 ▲:CH UP
- 4 ▼:CH DOWN
- ▶:VOL UP
- ◀:VOL DOWN
- 1 ACTION
- 2
- 5

Note

Due to the earth's magnetic fields, or magnetic charge build-up from nearby electrical appliances, color distortion may occur if the Combination VCR direction is changed while it is on. To avoid this, position the Combination VCR before turning it on. If this phenomenon does occur, press the POWER off and then on again.

Picture Adjustment

- COLOR Control**
Adjust color intensity.
- TINT Control**
Adjust for natural flesh tones.
- BRIGHTNESS Control**
Adjust picture brightness.
- PICTURE Control**
Adjust picture intensity by adjusting both contrast and color level in the proper balance.
- SHARPNESS Control**
Adjust picture sharpness.

Playback a Tape

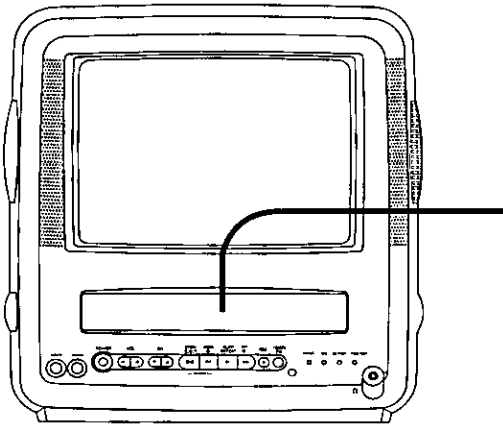

Check list before you begin.

- All connections are made (see page 6.)
- Your Combination VCR is plugged in.

1

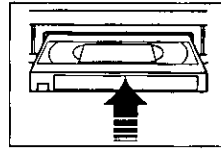

Insert a cassette.

Note

To prevent tape jam

Inspect your cassette tapes and remove any loose or peeling labels.

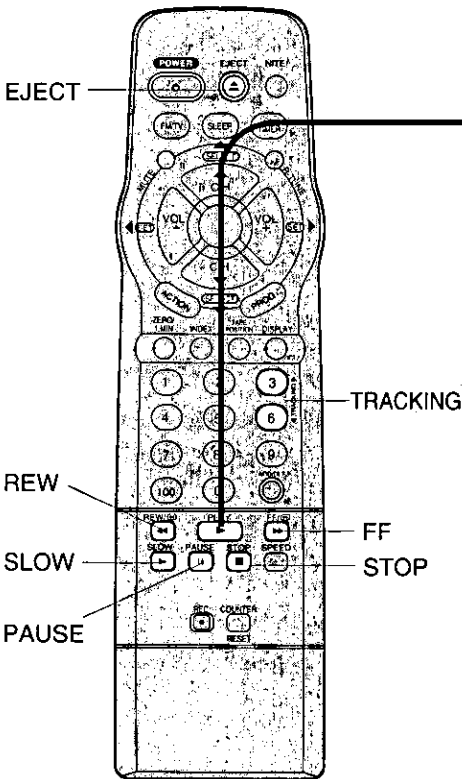
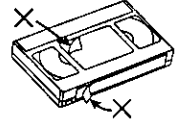

2



Press **PLAY**.

- Playback begins if cassette has no record tab.

■ To Find a Particular Scene

- Forward Search → Press FF
- Reverse Search → Press REW

■ For view Slow Motion →

- Press SLOW (To release, press SLOW)

■ For view Still (Freeze) picture →

- Press PAUSE (To release, press PAUSE)

■ For view Frame by Frame picture →

- Press SLOW in the Still mode
(To release, press PAUSE)

Note

After Combination VCR is in Still or Slow mode for 3 minutes, it will switch to Stop mode automatically to protect the tape and the video head.

■ To stop → Press STOP

■ To rewind tape → Press REW in stop mode

■ To eject tape → Press EJECT on the remote or STOP/EJECT on the Combination VCR

Features for Quality Picture

Digital Auto Tracking

Continuously analyzes the signal and adjusts for optimum picture quality.

Manual Tracking Control (to reduce picture noise)

Use during Playback and Slow Motion mode to reduce picture noise.

Press the 3 or 6 NUMBERED key on the remote control or CH ▲▼ on the Combination VCR until the picture clears up.

To return to Auto Tracking, press POWER off, then on again a few seconds later.

You can operate on the Combination VCR

1 Insert a cassette.

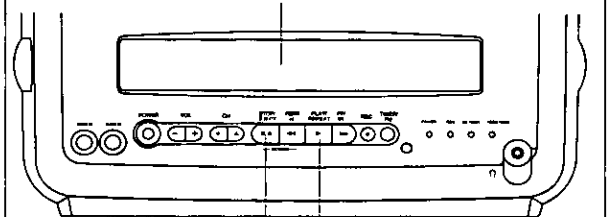

2 Press PLAY.

- Press to stop and/or eject tape.

Record On a Tape

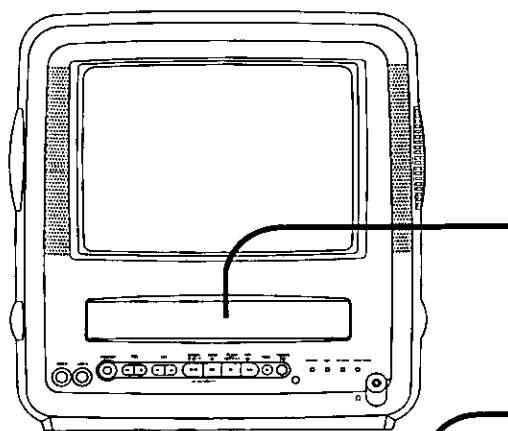

Check list before you begin.

- All connections are made (see page 6.)
- Your Combination VCR is plugged in.
- Cassette with record tab in place.

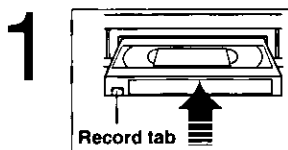

Insert a cassette.
 • Combination VCR power comes on automatically.

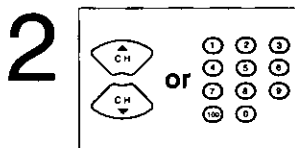

Select Channel.
 Press CH ▲▼, or NUMBERED keys.
 • To select "LINE," see bottom of this page.

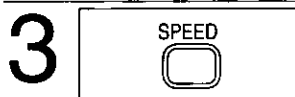

Select Recording speed (see page 5.)
 Press SPEED.
 SP = Standard Play
 LP = Long Play
 SLP = Super Long Play
 • Selected speed is displayed.

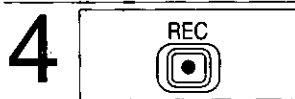

Start Recording.
 Press REC.
 • To edit out unwanted portions, press PAUSE to pause and resume recording.
 • You can not view another channel during recording.

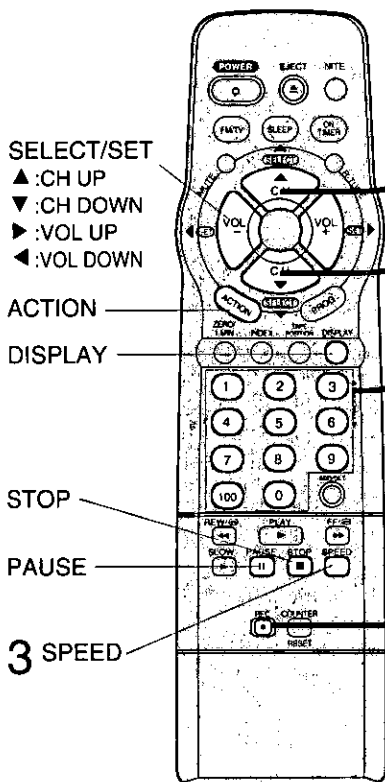

- **To stop → Press STOP**
 • When using DC Power supply, pressing POWER on the remote will cancel Recording in progress.
- **One Touch Recording (OTR)**
 Press REC repeatedly to set the recording length (30 min - 4 hours.)
 • Combination VCR stops recording at a preset time.
- PROG TIMER indicator lights on the Combination VCR.

Notes

- After Combination VCR has been in Rec Pause mode for 5 minutes, it will stop automatically to protect the tape and video head.
- The remaining recording time of an OTR can be displayed by pressing DISPLAY.
- When using DC Power supply, pressing POWER on the Combination VCR will cancel an OTR in progress.

Selecting Input Mode

Method: 1
 Press CH ▲▼. The display will change as follows.

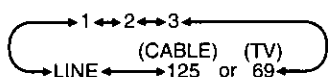

- Method: 2
- a Press ACTION for MAIN MENU.
 - b Press ▲▼◀▶ to select "TV", then press ACTION for SET UP TV screen.
 - c Press ▲▼ to select "INPUT SELECT," and then press ► to select "TUNER" or "LINE."
 - d Press ACTION twice to exit this mode.

You can operate on the Combination VCR

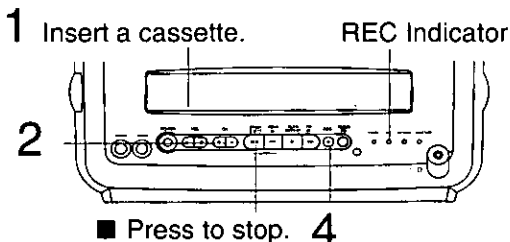

Timer Recording

You can set up to 8 programs to be recorded while you are away.

1



Display SET PROGRAM.

Press PROG.

- If a program is already in memory, press ▲▼, and ► to select an unused program number.

2

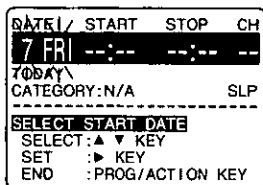

Set the recording DATE.

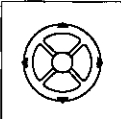

- 1) Press ▲▼ to select.
- 2) Press ► or ◀ to set.

- 1-31 = One time
- DAILY = MON-FRI
- WEEKLY SUN-SAT = Same time once a week

Example

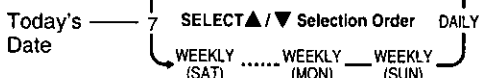

Repeat step 2 to set:

- start time, stop time
- Channel (or LINE for outside source)
- Category [N/A (not applicable), SPORTS, MOVIE, COMEDY, MUSIC, DRAMA]
- Speed (SP, LP, SLP)

3

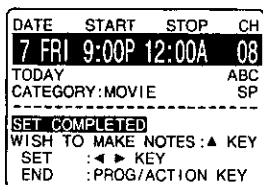

Make the notes.

- If not wanted, go to step 4.

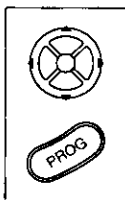

- 1) Press ▲ to begin.
- 2) Press ▲▼ to select.
- 3) Press ► or ◀ to set.
- 4) Press PROG (or ACTION) to end.

- Characters will change in the following order.

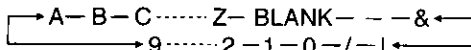

Continued on the next page.

Notes

- If "PLEASE PREPARE FOR TIMER REC" appears and/or the PROGRAM TIMER indicator flashes, check that a cassette with record tab is loaded and the Combination VCR is in Stop mode.
- If the start times of two programs overlap, the lower numbered program will have priority.
- If the start time for a Timer Recording comes up during a normal recording or One Touch Recording (page 13), the Timer Recording will not be performed.
- If there is a power interruption of more than one minute, the recording may not be performed or continue.
- If "INCOMPLETE" appears after all items have been set, check all entries and make necessary corrections.
- When using DC Power supply, a Timer Recording can not be performed if POWER on the Combination VCR is pressed OFF.



Check list before you begin.

- All connections are made (see page 6.)
- Your Combination VCR is plugged in.
- The clock is set to correct time.
- The tape is long enough.
- The record tab is in place.

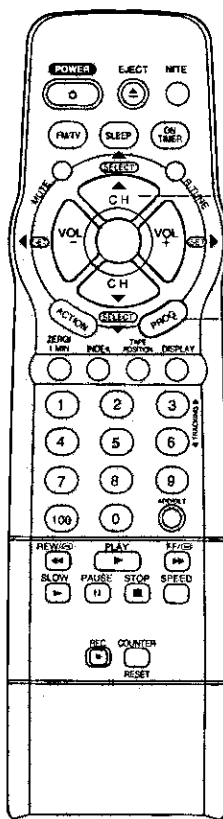

1. PROG
2. SELECT/SET
3. ▲:CH UP
▼:CH DOWN
►:VOL UP
◀:VOL DOWN
- 4.
- 5.

Timer Recording Using Combination VCR Buttons

You can set the Timer Recording using ACTION key on the Combination VCR. (See page 9.)

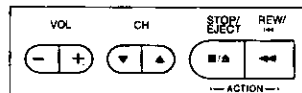

- 1 Press STOP/EJECT and REW together without a tape to display MAIN MENU.
- 2 Press ▲▼◀▶ to select "VCR" and STOP/EJECT and REW together to display SET UP VCR screen.
- 3 Press ▲▼ to select "TIMER PROGRAM" and ► to display the TIMER PROGRAM screen.
- 4 Repeat steps 2-5.

14

For assistance, call 1-800-211-PANA(7262)

4

P	DT	START	STOP	CH	SPD
1	day	9:00p	12:00a	08	SP
2	---	---	---	---	---
3	---	---	---	---	---
4	---	---	---	---	---

CANCEL: ADD/DLT KEY
 SELECT 1-8: ▲▼ KEY
 ENTER: ► KEY
 END: :PROG/ACTION KEY

End the program.



Press PROG (or ACTION.)

To Enter More Programs

Press ▲▼ and ► to select and set a blank program number, and then repeat steps 2 and 3.

Cancel a Timer Recording: (Recording is in progress)

Hold down STOP for a few seconds to cancel the Timer Recording.

- Any future daily or weekly recordings will be performed as programmed.

5



Exit this mode.

Press PROG (or ACTION.)

- If you're using a cable box, make sure that it is tuned to the desired channel and the power is left on for timer recording.
- PROG TIMER indicator lights on the Combination VCR.

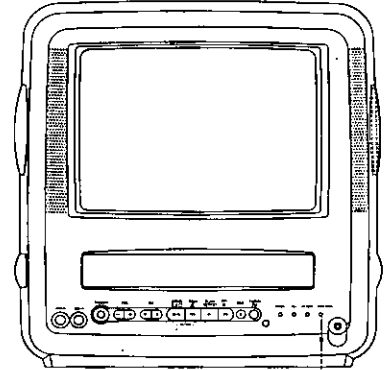

PROG TIMER indicator

Review, Replace or Clear Program Contents: (Recording is not in progress)

a



Display SET PROGRAM.

Press PROG.

b

P	DT	START	STOP	CH	SPD
1	day	9:00p	12:00a	08	SP
2	8	10:00a	12:00p	125	SP
3	10	8:00p	9:00p	10	SP
4	SU	9:00p	10:00p	L	LP

CANCEL: ADD/DLT KEY
 SELECT 1-8: ▲▼ KEY
 ENTER: ► KEY
 END: :PROG/ACTION KEY

Select the desired program.

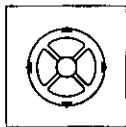

Press ▲▼ to select.

C

To Replace program...

DATE/	START	STOP	CH
8 SAT	9:00P	12:00A	08
TODAY			ABC
CATEGORY:	MOVIE		SP
NOTES:	STAND BY ME		
SELECT START DATE			
SELECT:	▲▼ KEY		
SET:	► KEY		
END:	:PROG/ACTION KEY		

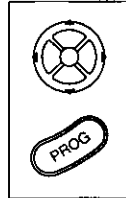

- 1) Press ► to display.
- 2) Press ▲▼◀▶ to set new program contents.
- 3) Press PROG (or ACTION.)

To Clear program...

P	DT	START	STOP	CH	SPD
1	---	---	---	---	---
2	8	10:00p	12:00a	125	SP
3	10	8:00p	9:00p	10	SP
4	SU	9:00p	10:00p	L	LP

SELECT 1-8: ▲▼ KEY
 ENTER: ► KEY
 END: :PROG/ACTION KEY

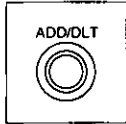

Press ADD/DLT.

d



Exit this mode.

Press PROG (or ACTION.)

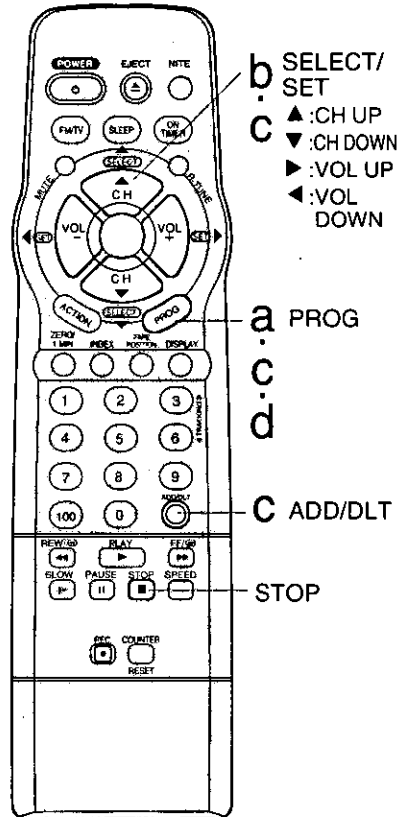

- b. SELECT/SET
- c. ▲: CH UP
- c. ▼: CH DOWN
- c. ►: VOL UP
- c. ◀: VOL DOWN

- a. PROG
- c. C
- C. ADD/DLT
- STOP

Advanced Operation

TV Timer Features

ON-TIMER with Alarm

Combination VCR can be set to automatically power on in one of 3 modes (TV, Playback, or FM radio.) You can also combine the On-Timer with a one minute alarm that gradually increases in volume.

Check list before you begin.

The clock is set to correct time.

1  **Display ON TIMER screen.**
Press ON-TIMER.

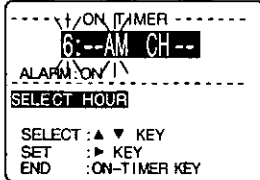
2  **Set the ON-TIMER DATE.**

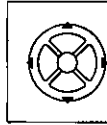

- 1) Press ▲▼ to select.
 - 2) Press ► to set.
- Make sure a tape is inserted if Playback mode is selected.
 - See "FM Radio Setup" on page 20 and 21 for instructions on how to preset FM stations.

• ON-TIMER mode selection order

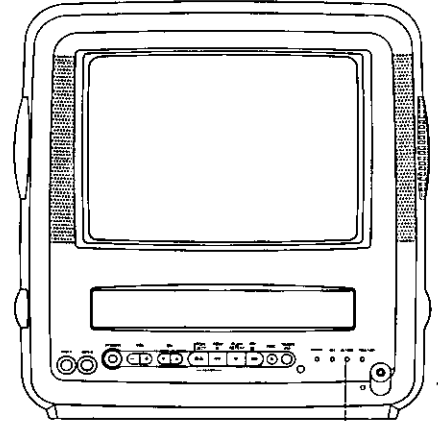
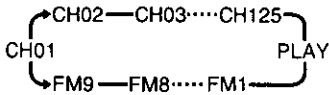

ON-TIMER Indicator

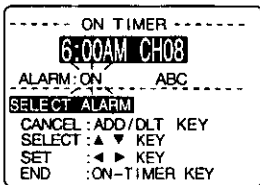
3  **Set Alarm.**

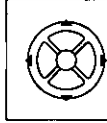

Press ▲▼ to select "ON" or "OFF."

When "ON" is selected, an alarm will gradually increase in volume for one minute or until cancelled by pressing any button (including VOL ◀▶.)

To Make Corrections, use ▲▼ and ◀▶ to move back and correct as necessary.

4  **Set ON TIMER.**
Press ON-TIMER.

• ON-TIMER indicator lights on the Combination VCR.

To cancel ON-TIMER set, press ON-TIMER to redisplay the screen in step 3. Then, press ADD/HLT to clear the time ("6" is flashing.) Now, press ON-TIMER to end. "ON-TIMER END" appears on-screen for a few seconds.

Note

If no button on the remote or Combination VCR (including a button used to turn off the alarm) is pressed within 60 minutes after Combination VCR turns itself on, it will turn itself back off.

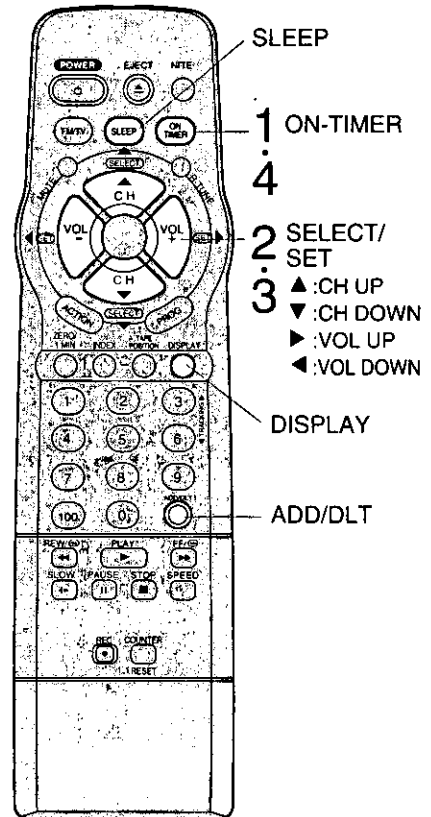

SLEEP TIMER

Combination VCR can be set for auto power off.

Set SLEEP TIMER.



Press SLEEP repeatedly.

- Pressing DISPLAY with sleep timer set displays remaining time.

To Cancel, press SLEEP repeatedly until "SLEEP TIMER 00" appears.

- SLEEP TIMER 30
- SLEEP TIMER 60
- SLEEP TIMER 90
- SLEEP TIMER 00

INSTANT ALARM

The feature allows you to set a timer alarm for up to 60 minutes. Useful for when you are cooking and need to leave the kitchen.

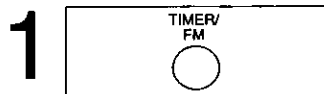

1 Display INSTANT ALARM screen.

Press **TIMER/FM** on the Combination VCR to display.

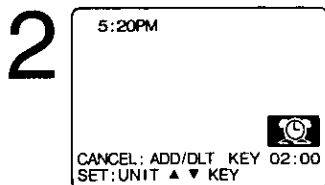

2 Set Alarm.

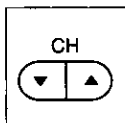

Press **CH ▲▼** on the Combination VCR to select time (see below.)

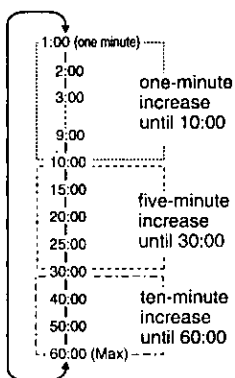

- Countdown starts 3 seconds after alarm is set.

To cancel, press **ADD/HLT**.

To increase timer in progress, Press **CH ▲▼** to restart countdown rounded up to next 1, 5, or 10 minute interval.

<Example>

- If current time remaining is 12:15, countdown will restart from 15:00.
- If current time remaining is 9:15, countdown will restart from 10:00.

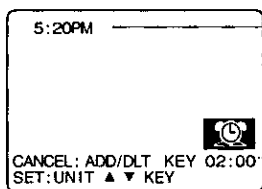

The current time (if clock is set) and time remaining display change positions on the screen every 10 seconds.

Remaining Time

3 Alarm will go off at 0:00.

Press any button to stop.

- The volume of the alarm gradually increases for one minute and then continues to beep until any button is pressed.

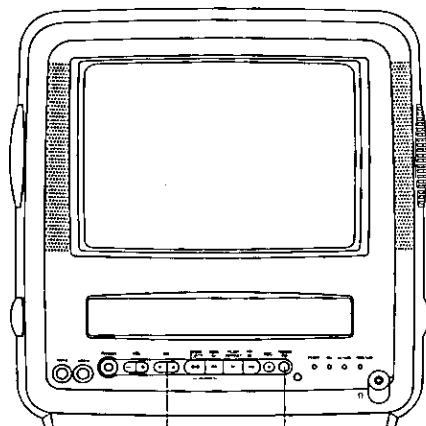

2 CH ▲▼ 1 TIMER/FM

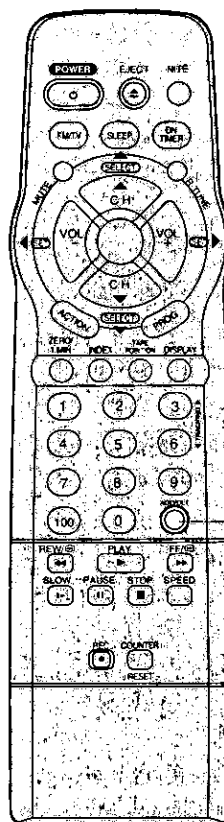

ADD/HLT

Note

When watching TV while INSTANT ALARM is in progress, only use **CH ▲▼** on remote to change channels.

Closed Caption System

Closed Caption Mode Feature

1  **Display MAIN MENU.**
Press ACTION.

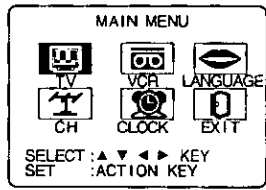
2  **Display SET UP TV screen.**
1) Press ▲▼◀▶ to select "TV."
2) Press ACTION to display.

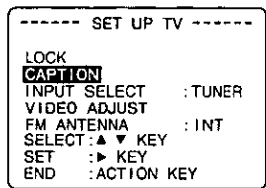
3  **Display CAPTION screen.**
1) Press ▲▼ to select.
2) Press ▶ to display.

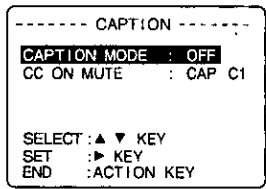
4  **Select CAPTION MODE.**
1) Press ▲▼ to select.
2) Press ▶ repeatedly to select caption mode.

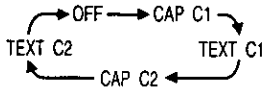

5  **Return to the normal screen.**
Press ACTION three times.

Closed Caption is ...
This multi-use system not only allows the hearing impaired to enjoy selected programs, but also makes useful information from TV stations available to everyone.

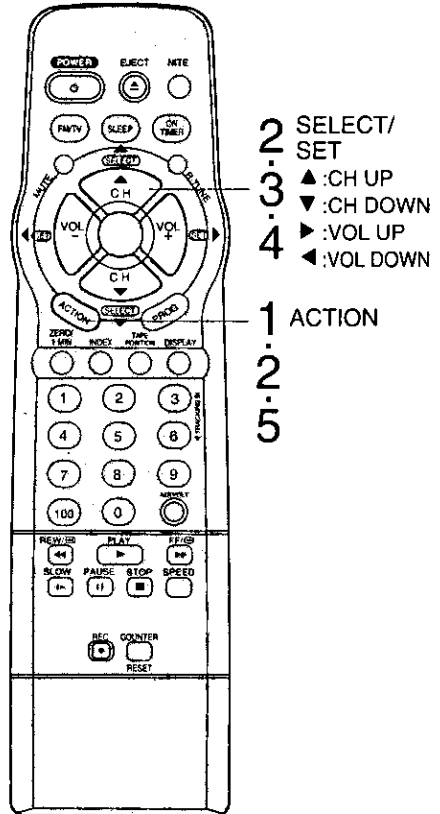

Closed Caption Modes From which to Choose

Caption Mode: CAP C1 or C2
A narration of selected TV programs is displayed. Check TV program listings for C.C. (Closed Caption) broadcasts.

Caption Mode: TEXT C1 or C2
The lower half of the screen will be blocked out. When the TV station broadcasts information, such as program listings, it will appear in this space.

Caption Mode: OFF
Closed Caption/Text narration will not be displayed.

NOTE:
The closed caption or text signal may be broadcast over C1, C2, or both. Also, text contents can vary so you may wish to try different settings.

Recording and Playing Back a Closed Caption/Text Program

Record:
Record normally. Closed Caption/Text signal, if present, is recorded automatically.

Playback:
Start playback. Do above steps to select desired caption mode.

Caption On Mute Feature

Closed Caption narration, if available, is displayed when MUTE button is pressed for silence.



1 Display MAIN MENU.
Press ACTION.

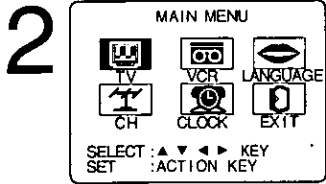

2 Display SET UP TV screen.

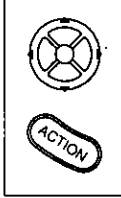

- 1) Press ▲▼◀▶ to select "TV."
- 2) Press ACTION to display.

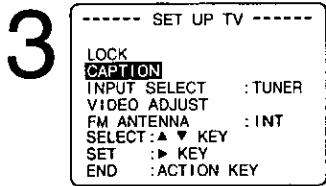

3 Display CAPTION screen.

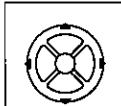

- 1) Press ▲▼ to select.
- 2) Press ▶ to display.

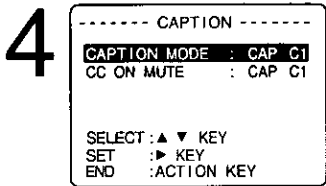

4 Set CAPTION MODE OFF.

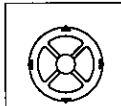

- 1) Press ▲▼ to select.
- 2) Press ▶ repeatedly to select "OFF."

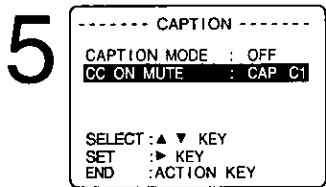

5 Select CC ON MUTE.

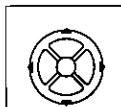

- 1) Press ▲▼ to select.
- 2) Press ▶ repeatedly to select desired caption mode.

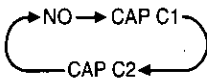

- Each press of ▶ will change the display as shown at left.
- The caption may be broadcast over CAP C1 or C2.

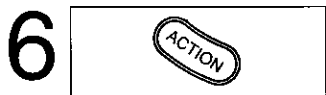

6 Return to the normal screen.
Press ACTION three times.

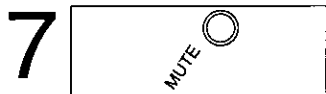

7 Mute sound, display closed captioning.
Press MUTE to mute the sound.
• To cancel, press MUTE again.

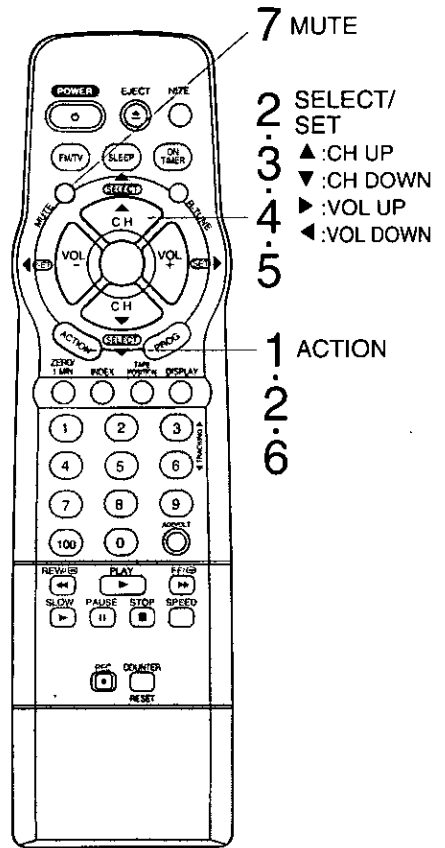

FM Radio

FM Radio is...

The Combination VCR has an FM radio with built-in antenna, 9 station preset, and a band range of 87.5~108.1 MHz. You can even set the On-Timer (page 16) to wake up to your favorite music station.

FM ANTENNA Setup

1  **Display MAIN MENU.**
Press ACTION.

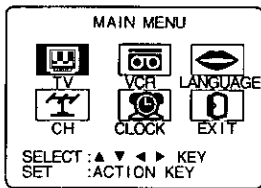
2  **Display SET UP TV screen.**

1) Press ▲▼◀▶ to select "TV."
2) Press ACTION to display.

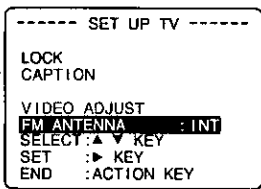
3  **Select FM ANTENNA.**

1) Press ▲▼ to select.
2) Press ▶ for "INT (INTERNAL)" or "EXT (EXTERNAL)."

- If you do not have a cable box → "INT"
- If you have a cable box → "EXT"

Note

If, due to the cable box used, you do not receive the desired radio station during FM radio Setup (page 21), please select FM ANTENNA: "INT."

4  **End setup.**
Press ACTION twice to exit.

FM Radio Setup

a  **Display FM radio mode.**
Press FM/TV on the remote or TIMER/FM twice on the Combination VCR.

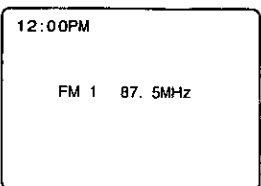
b  **Select the FM number.**

Press a NUMBERED key (1~9).

Continued on the next page.

Process of FM Radio

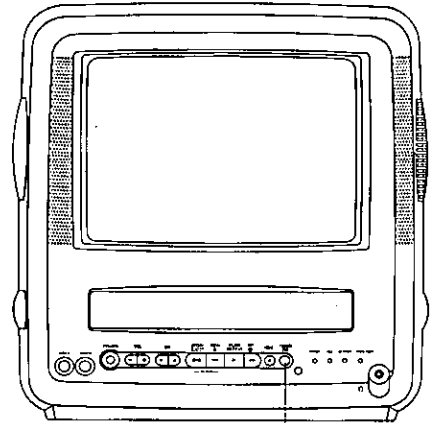

a TIMER/FM

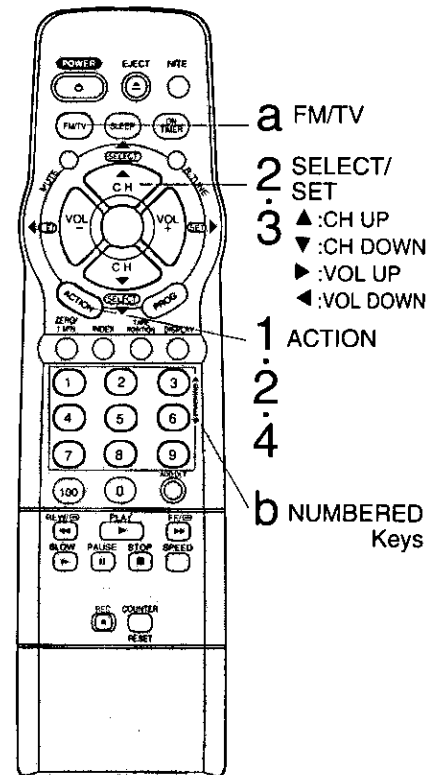

a FM/TV

2 SELECT/SET

3 ▲:CH UP
▼:CH DOWN
▶:VOL UP
◀:VOL DOWN

1 ACTION

2
4

b NUMBERED Keys

Notes

- If INDEX is pressed while in the FM radio mode, you will not be able to select other stations with the NUMBERED keys.
- FM radio stations cannot be recorded on a Video cassette.
- You may get better reception by repositioning the Combination VCR.
- You cannot select FM Radio mode during playback or record, or while a blue back screen (ACTION, PROG, and ON-TIMER) is displayed.

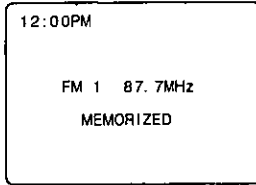
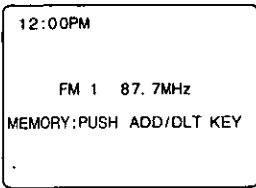
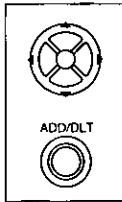
C**Set the radio station.**

- 1) Press ▲▼ to select the desired radio station. (Each press changes frequency 200 KHz.)
- 2) Press ADD/DLT to set.

Quick Station Scan

Hold down ▲ or ▼ more than 1 second, then release to scan for FM stations in your area.

- To cancel, press ▲ or ▼ while in search mode.

To Make Corrections, select station with a NUMBERED key, then do step c again.

To exit FM mode, press FM/TV on the remote or TIMER/FM twice on the Combination VCR.

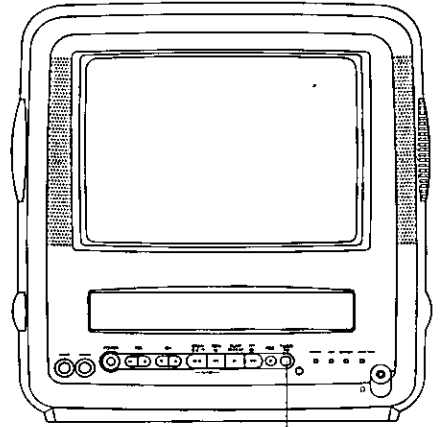
Process of FM Radio**A** TIMER/FM**Using FM Radio****A****Display FM radio mode.**

Press FM/TV on the remote and TIMER/FM twice on the Combination VCR.

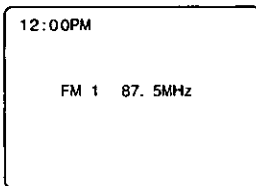
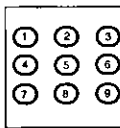
B**Select the FM number.**

Press a NUMBERED key (1~9) to select a preset station (see steps b and c.)

To cancel, press FM/TV on the remote or TIMER/FM twice on the Combination VCR.

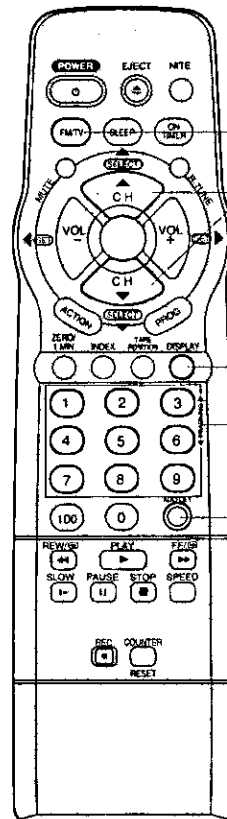
**A** FM/TV**C** SELECT
▲:CH UP
▼:CH DOWN

DISPLAY

B NUMBERED
Keys**C** ADD/DLT**Note**

Once stations are set, the selected station and current time are displayed when FM radio mode is entered.

The station disappears in 10 seconds.

To remove time, press DISPLAY.

If DISPLAY is pressed while station is still on the screen, or when there is no display, the Combination VCR status screen appears.

Tape Operation

Tape Position Display

To find out the present tape position.

Tape position cannot be found for C-Cassette type and tape of less than 60 minutes.



Detect Tape Position.
Press TAPE POSITION.



- "DETECTING TAPE POSITION" is displayed only when first cassette in.
- It takes several seconds for correct tape position to appear.

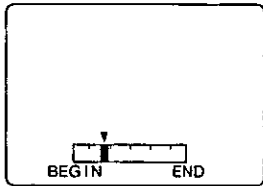

- Indication is standard.

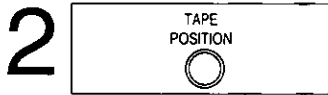

Return to normal screen.
Press TAPE POSITION.

Zero Search

To quickly return to a specific tape counter location.

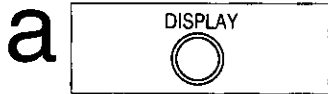

Display the Counter.
Press DISPLAY during playback.

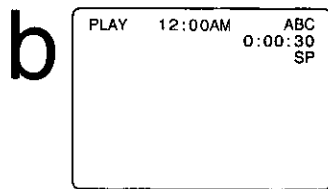

Reset to "0:00:00."
Press COUNTER RESET at the desired position.



c Continue playback, rewind, or fast forward.

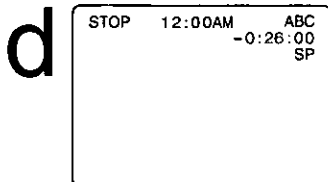

Return to "0:00:00."
Press ZERO/1 MIN in Stop mode.

- The Combination VCR will go into FF or REW mode and stop at the last point the Counter was set to 0:00:00.

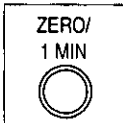

Your Combination VCR is equipped with several time saving features as well as convenient automatic functions which make tape operation easier than ever.

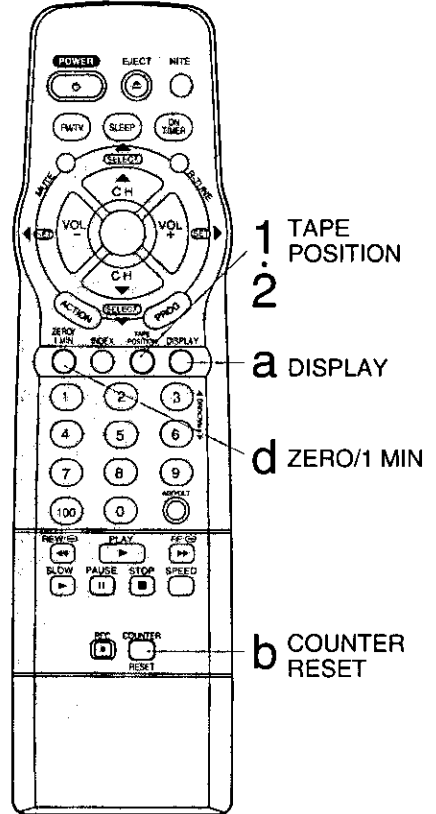

Repeat Play

Set to see a recording over and over.

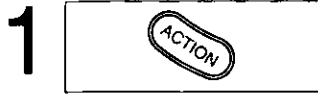

Display MAIN MENU.
Press ACTION.

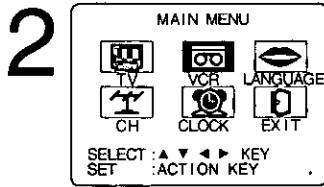

Display SET UP VCR screen.

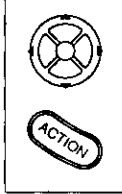

- 1) Press ▲▼◀▶ to select "VCR."
- 2) Press ACTION to display.

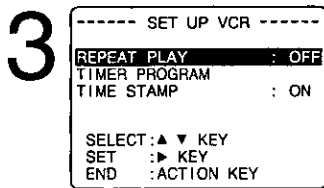

Select REPEAT PLAY.

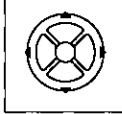

- 1) Press ▲▼ to select.
- 2) Press ▶ to set "ON" or "OFF."

Notes

- Playback repeats when tape end is reached or unrecorded portion over 30 seconds is detected.
- During playback, you may also press PLAY/REPEAT repeatedly on the Combination VCR to select REPEAT "ON" or "OFF."

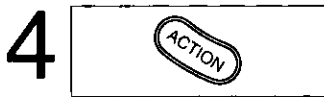

End setup.
Press ACTION twice.

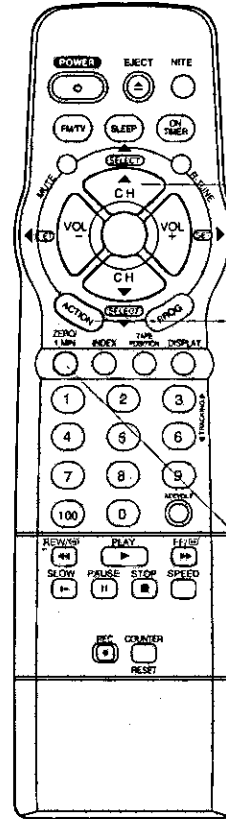

- 2 SELECT/SET
3 ▲:CH UP
▼:CH DOWN
▶:VOL UP
◀:VOL DOWN
1 ACTION

- 2
4

ZERO/
1 MIN

Auto Operation Functions

■ Auto Shut Off

No broadcast signal in TV, NITE or Playback mode for 5 minutes → Turn Power off automatically

- This feature is deactivated if any button is pressed during the above mode.

■ Auto Playback

Insert a tape in Power off mode → Turn Power on automatically

- Playback begins automatically if a tape has no record tab.
- This feature cannot be activated when the POWER button on the Combination VCR is turned OFF (POWER indicator is not lit.)

■ Auto Rewind

A tape reaches its end → Rewind begins → Stop automatically

■ Playback Auto Eject (Repeat Play is "OFF")

A tape has no record tab reaches its end → Rewind begins → Eject automatically

■ Memory Rewind off (Only AC POWER)

Press POWER in REW mode → Rewind is completed → Turn Power off automatically

One Minute Skip

Combination VCR fast forwards over 60 seconds of recorded tape.

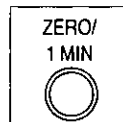

Skip over 1 minute.

Press ZERO/1 MIN in Play mode.

Tape Operation (continued)

Direct Access (For Normal and/or Timer recordings)

Go directly to the desired recording.

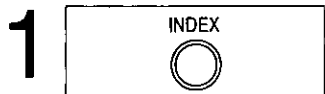

Display INDEX screen.

Press INDEX in Playback or Stop mode.

- If there are no Timer Recordings on the Program Index List or when using DC Power supply, go to step 3.

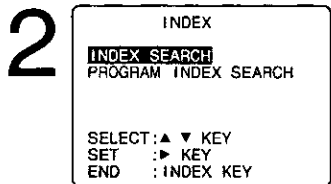

Display INDEX screen.

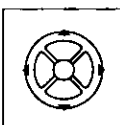

- 1) Press ▲▼ to select "INDEX SEARCH."
- 2) Press ► to display.

- This screen appears only if there are Timer Recordings.

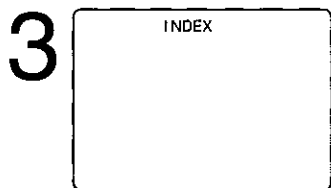

Select the recording number.

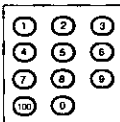

Press **NUMBERED** keys.

- To calculate number, see below.

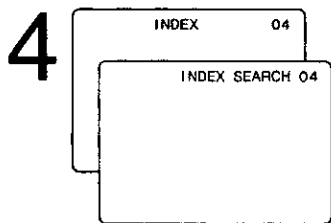

Start search.

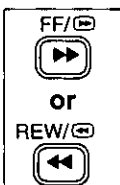

Press **FF** or **REW**.

- When search is finished, playback begins.

To calculate the Index Number

Example 1:

If you are watching recording 4 and you want to watch recording 2, enter 3 in step "3" and press REW.

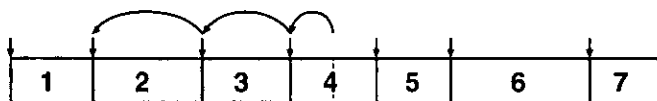

Example 2:

If you are watching recording 2 and you want to watch recording 6, enter 4 in step "3" and press FF.

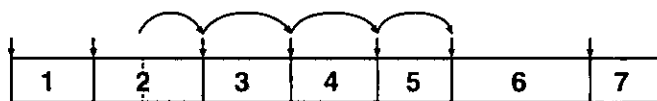

NOTE: ↓ indicates start points of each recording.

VHS Index Search System is ...

Each time recording is made, an invisible index mark is placed on the tape. When timer recordings are made, program index and information are also included. (Only AC POWER) These index marks can be used to access or scan recordings.

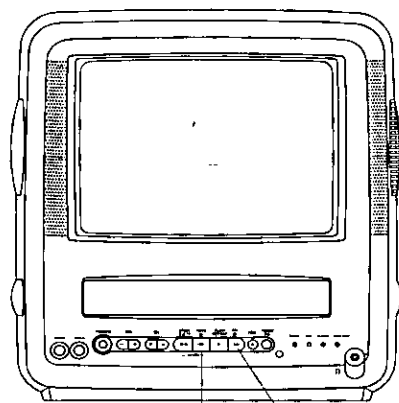

4 REW 4 FF

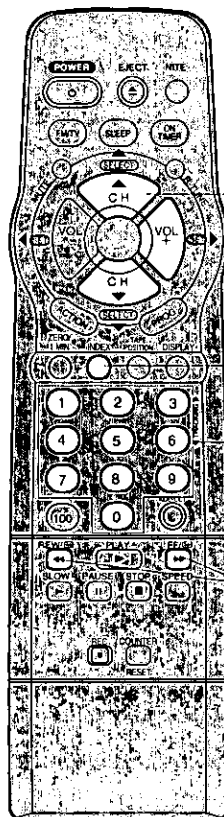

2 SELECT/SET
▲: CH UP
▼: CH DOWN
►: VOL UP

1 INDEX

3 NUMBERED keys

4 FF or REW

Notes

- Make each entry within 10 seconds, or the Index Search mode will be canceled.
- If these VHS Index Search Systems are started very close to an index mark, that index mark may not be counted in the search.

Program Index Search (For Timer recordings only)

(Only AC POWER)

Choose a timer recorded program from a Program index List. When the tape is ejected or normal recording is started, all program index data are deleted.

1  **Display INDEX screen.**
Press INDEX in Playback or Stop mode.

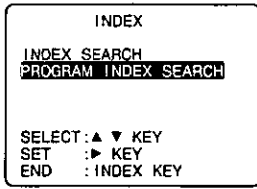
2  **Display PROGRAM INDEX screen.**
1) Press ▲▼ to select "PROGRAM INDEX SEARCH."
2) Press ► to display.

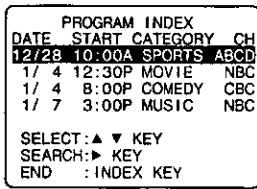
3  **Select the desired recorded program.**
1) Press ▲▼ to select.
2) Press ► to start the forward or rewind search.
• When search is finished, playback begins.

Index Scan (For Normal and/or Timer recordings)

In Play mode, the first 10 seconds of each recording can be scanned (forward or reverse.)

a Repeat steps 1 and 2 on previous page to display INDEX screen.

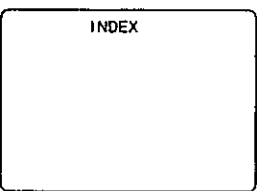
b  **Start the scan.**
Press FF or REW.

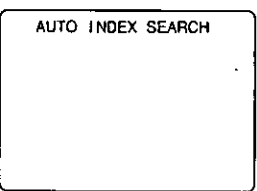
c  **Cancel scan, start playback.**
Press PLAY.
• To stop, press STOP.

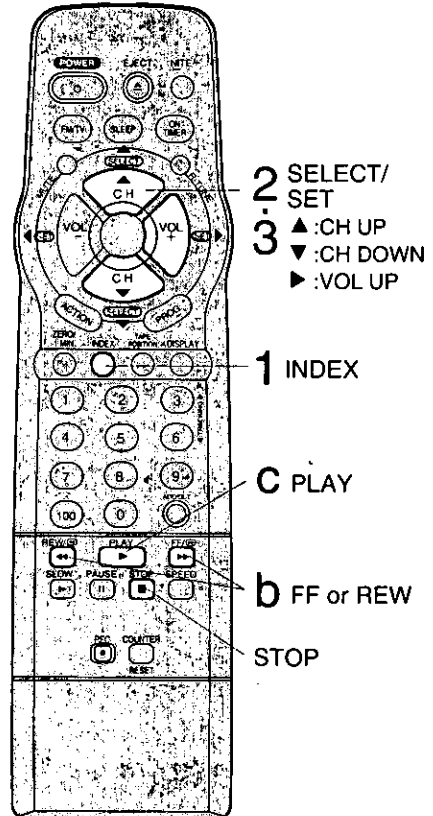
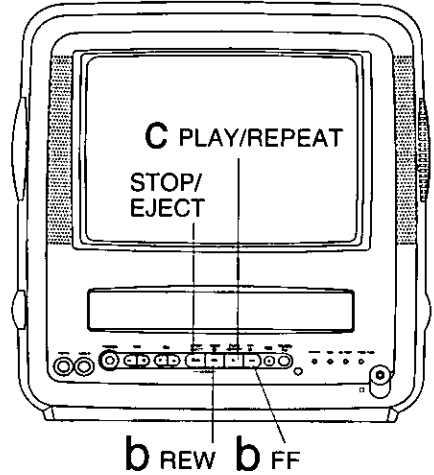

<Example>

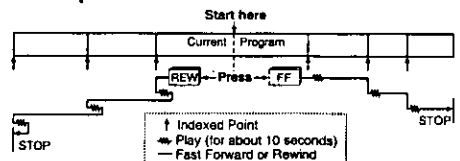

Special VCR Features

Preset Caption



Display MAIN MENU.
Press ACTION.

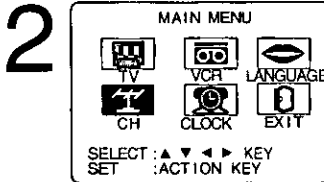

Display SET UP CH screen.

- 1) Press ▲▼◀▶ to select "CH."
- 2) Press ACTION to display.

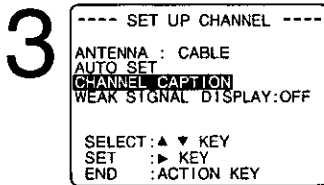
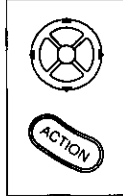

Select CHANNEL CAPTION.

- 1) Press ▲▼ to select.
- 2) Press ▶ to display.

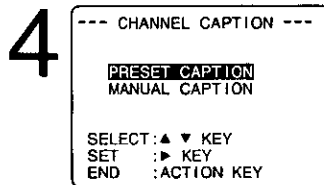
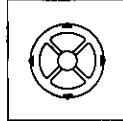

Select PRESET CAPTION.

- 1) Press ▲▼ to select.
- 2) Press ▶ to display.

- To create your own captions, go to "Manual Caption" on page 27.

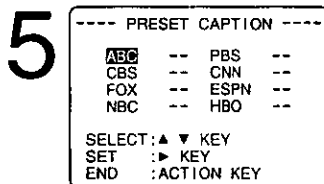
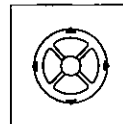

Go with preset captions.

- 1) Press ▲▼ to select a station.
- 2) Press ▶ to move cursor to the right.
- 3) Press ▲▼ to select channel number.
- 4) Press ◀ to set.

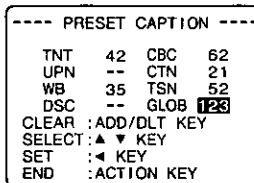
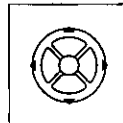

- Repeat step 5 until the Caption List is complete.

To Make Corrections

Press ▲▼, then ▶ to select channel number. Press ▲▼ to change, or ADD/DLT to delete.

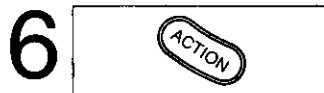

End setup.
Press ACTION four times.

Channel Caption is ...

Station names, e.g. ABC, TNT, etc. can be set so they will appear when a channel is selected. Choose 24 preset names (Preset Caption), or make up to 10 names of your own (Manual Caption.)

Check list before you begin.

You need a list of stations and the channel numbers you receive them on.

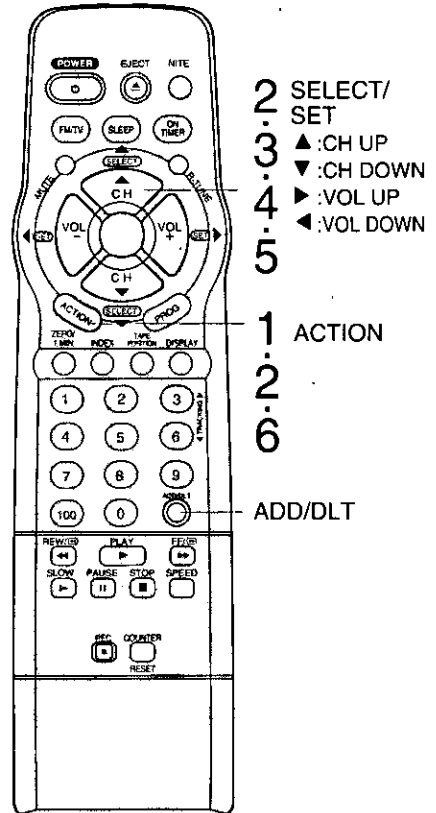

Manual Caption

1 Do "Preset Caption" steps 1~3 (page 26.)

2 **Select MANUAL CAPTION.**

--- CHANNEL CAPTION ---

PRESET CAPTION
MANUAL CAPTION

SELECT: ▲ ▼ KEY
SET : ► KEY
END : ACTION KEY

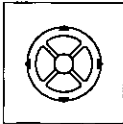

1) Press ▲▼ to select.

2) Press ► to display.

3 **Select Channel number.**

---- MANUAL CAPTION ----

CH NUMBER	CAPTION
02	----

SELECT: ▲ ▼ KEY
SET : ► KEY
END : ACTION KEY

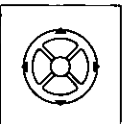

1) Press ▲▼ to select CH NUMBER.

2) Press ► to move cursor to the right.

- Channels already set and channels deleted from Channel Memory are not displayed.
- You can set a total of ten channel captions with up to four characters each.

4 **Enter your caption.**

---- MANUAL CAPTION ----

CH NUMBER	CAPTION
02	A----

CLEAR : ADD/DLT KEY
SELECT: ▲ ▼ KEY
SET : ► KEY
END : ACTION KEY

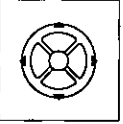

1) Press ▲▼ to select.

2) Press ► to enter.

• Characters change in the following order.

A—B—C—.....Z—BLANK— --&—
→9.....2-1-0-/-/!

- Press ◀ repeatedly to move the cursor to "CH NUMBER." Repeat steps 3 and 4 as desired.

To Make Corrections

Press ▲▼, then ► to select the channel number. Press ▲▼ to change, or ADD/DLT to delete.

5 **End setup.**
Press ACTION four times.



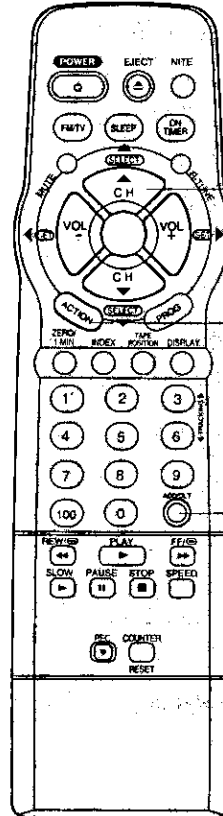

- 2 SELECT/SET
- 3 ▲:CH UP
▼:CH DOWN
- 4 ►:VOL UP
◀:VOL DOWN
- 5 ACTION
- ADD/DLT

Special VCR Features (continued)

Time Stamp Feature

Check list before you begin.

- The clock is set to correct time.
- The record tab is in place.

The Combination VCR writes program data (see example below) about the first 10 seconds of every recording. The information is then displayed the first 10 seconds of playback. To change the data, see "Changing Time Stamp Data" section on next page.

1  **Display MAIN MENU.**
Press ACTION.

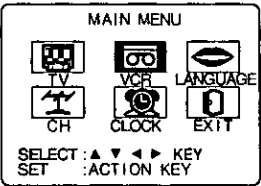
2  **Display SET UP VCR screen.**

1) Press ▲▼◀▶ to select "VCR."
2) Press ACTION to display.

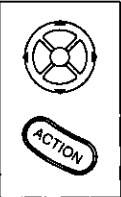

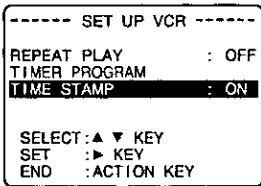
3  **Select TIME STAMP.**

1) Press ▲▼ to select.
2) Press ▶ to set "ON" or "OFF."

• When "OFF" is selected, the program data is written on the tape, but will not be displayed.

4  **Return to normal screen.**
Press ACTION twice.

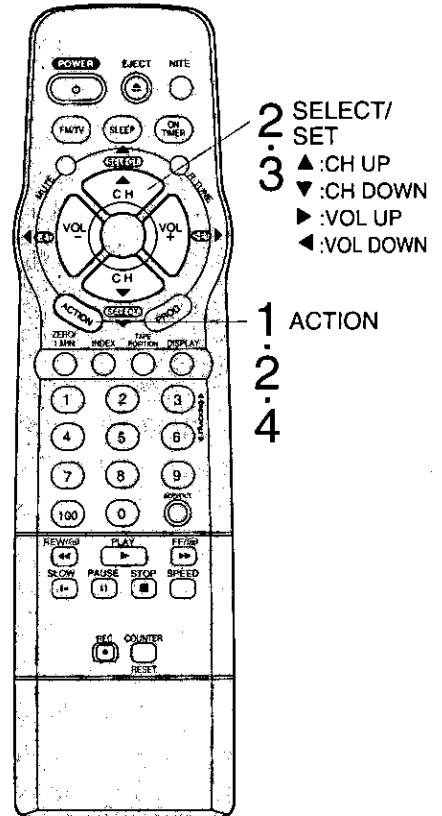

<Time Stamp Example >

Normal/ One
Touch Recording

12/28/1999 TUE
12:00PM
CH 08 ABC

Timer
Recording

12/27/1999 MON
12:00PM - 1:00PM
CH 08 ABC MOVIE
MEMORIAL MOVIE

When Clock is
not set...

---/--/---
CH 08 ABC

Changing Time Stamp Data

You may change the time stamp data (Date, Time, Channel, Category, and Notes) as desired.



Display Time Stamp Data.

- 1) Insert cassette with record tab.
- 2) Press PLAY.

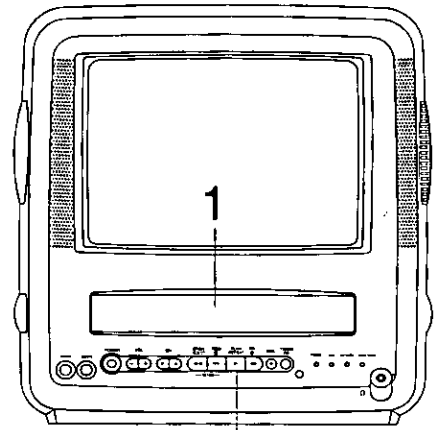

1 PLAY/REPEAT

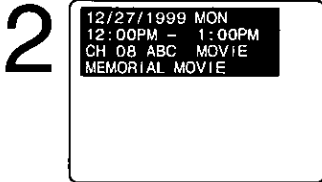

Display TIME STAMP EDIT.

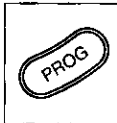

Press PROG while the data is displayed in playback mode.

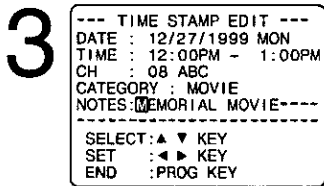

Change Time Stamp Data.

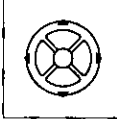

- 1) Press ▲▼ to select.
 - 2) Press ► or ◀ to enter and continue.
- Characters in NOTES will change in the following order.

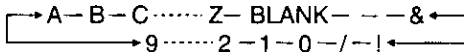

- 3) Repeat 1) and 2) as needed.

To Make Corrections
Press ◀▶ to move to the incorrect entry, then press ▲▼ to make the correction.

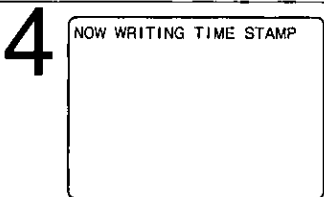

Write the new data.

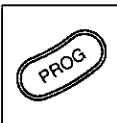

Press PROG.

- After the data is written, the Combination VCR automatically goes into Stop mode.
- You cannot use POWER or REC button while "NOW WRITING TIME STAMP" is displayed.

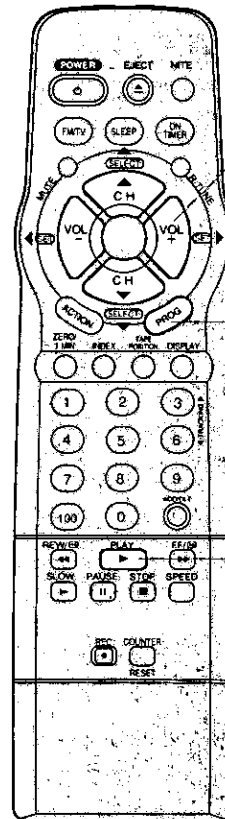

- 3 SELECT/SET
▲:CH UP
▼:CH DOWN
►:VOL UP
◀:VOL DOWN
- 2 4 PROG
- 1 PLAY

Special VCR Features (continued)

Weak Signal Display ON/OFF

When "ON" is selected, picture is displayed even when broadcast signal is weak or nonexistent.

1  **Display MAIN MENU.**
Press ACTION.

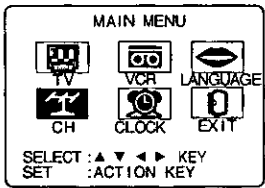
2  **Display SET UP CH screen.**

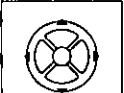
 1) Press ▲▼◀▶ to select "CH."
2) Press ACTION to display.



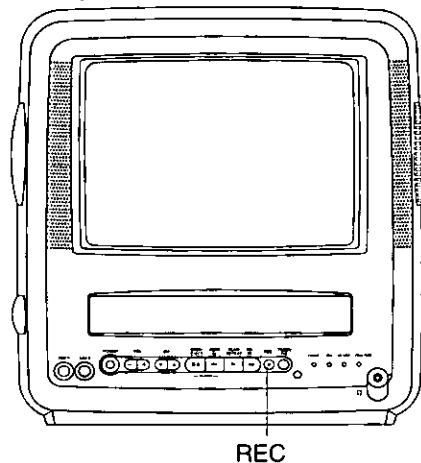

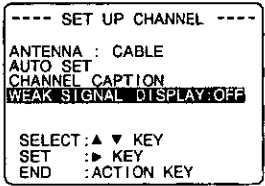
3  **Select WEAK SIGNAL DISPLAY.**

 1) Press ▲▼ to select.
2) Press ▶ to set "ON" or "OFF."

Notes

- "ON" = Picture is displayed regardless of signal condition, and may not always be clearly visible.
- "OFF" = Screen turns solid blue when signal is absent or weak.
- If Combination VCR is connected to equipment which has blue back feature, selecting "ON" will have no effect on the other equipment.

4  **Return to normal screen.**
Press ACTION twice.

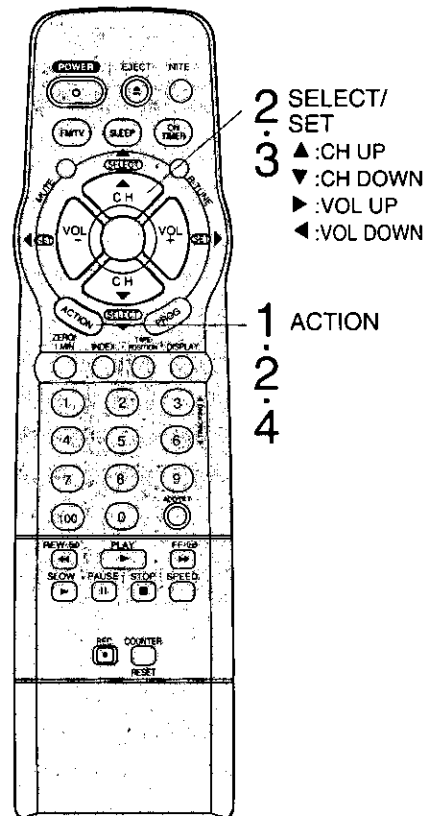

VCR Lock

All operations are prohibited except Timer recording and tape eject. Useful for families with small children.

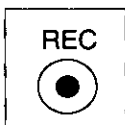
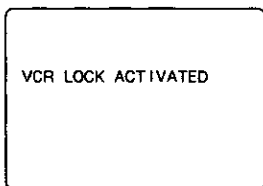

To turn "ON."
In stop mode, hold down REC on the Combination VCR without a cassette for 7 seconds.

To turn "OFF."
Repeat above with or without a cassette.

- VCR Lock is cancelled automatically after 24 hours if clock is set.
- This feature cannot to be activated when POWER on the Combination VCR is turned OFF (POWER indicator is not lit.)

Copying Your Tapes (Dubbing)

Connections you'll need to make.

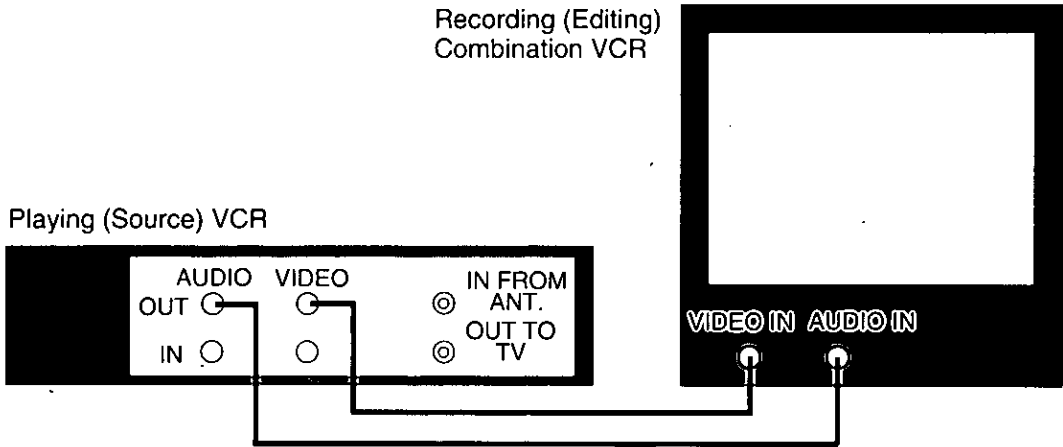

Playback (Source) VCR

Recording (Editing) Combination VCR

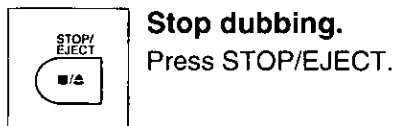
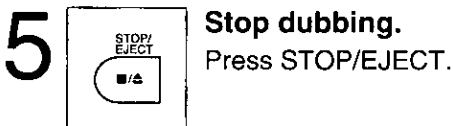
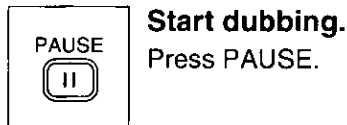
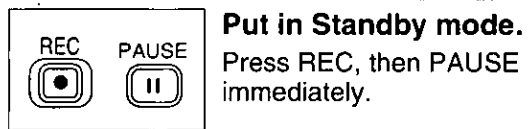
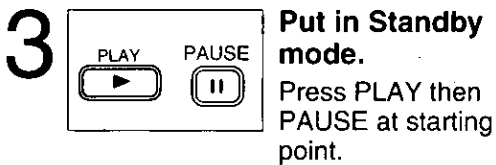
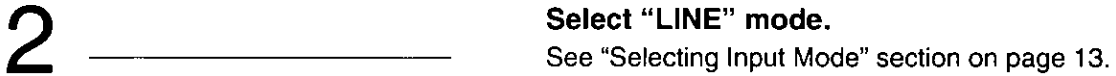

Caution: Unauthorized exchanging and/or copying of copyrighted recordings may be copyright infringement.

V-Chip Control Feature

V-Chip Control Feature is...

The Combination VCR has built-in V-Chip Control which allows you to block unwanted TV usage based on Motion Picture and TV Parental Guide ratings.

Process of V-Chip Control Feature

Enter Code ⇨ **Setup** ⇨ **Blocking**

Enter Secret Code

A 4 digit code must be entered to view a blocked program or change rating settings.

1  **Display MAIN MENU.**
Press ACTION.

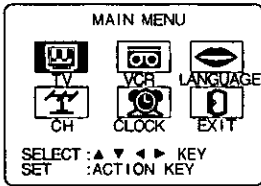
2  **Display SET UP TV screen.**
1) Press ▲▼◀▶ to select "TV."
2) Press ACTION to display.

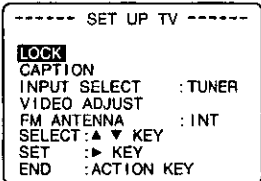
3  **Select LOCK.**
1) Press ▲▼ to select.
2) Press ▶ to display.

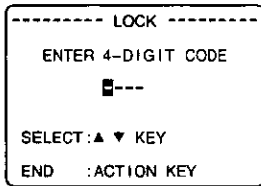
4  **Enter your secret code.**
1) Press ▲▼ to select a number.
2) Press ▶ (or ◀) to set.
• Repeat step 4 until 4-digit is filled.
• Take care that you are not observed entering the secret code.

To Make Corrections
Press ◀▶ to move the cursor and ▲▼ to make the correction.

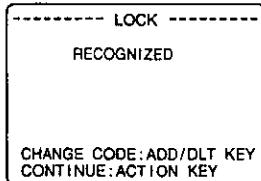
5  **Save 4-DIGIT CODE.**
Press ACTION.

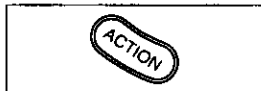
6  **Display LOCK menu for rating screen.**
Press ACTION and go to:
page 33 (MOTION PICT. Ratings),
or page 34 (TV PARENTAL Ratings)
Or,
to exit, press ACTION four times.

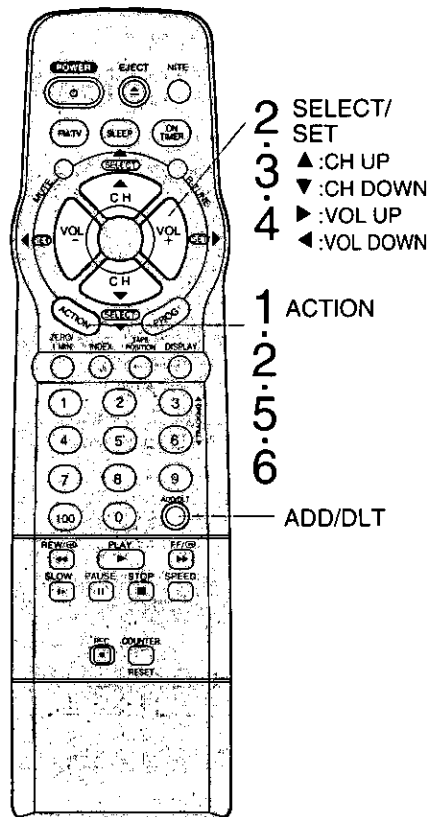

Change your secret code

• You will need your current code.
Do steps 1-4. In step 5, press ADD/DLT to clear current code.
Repeat steps 4 and 5 to enter new code.

Setup MOTION PICT. (PICTURE) Ratings

Process of V-Chip Control Feature

Enter Code → Setup → Blocking

If LOCK menu is not displayed, do "Enter Secret Code" steps on page 32.

1

```

----- LOCK -----
MOTION PICT. STATUS:OFF
CHANGE SETTINGS
TV PARENTAL STATUS :OFF
CHANGE SETTINGS

SELECT:▲▼KEY
SET :▶KEY
END :ACTION KEY
    
```

Select MOTION PICT. STATUS.

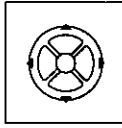

- 1) Press ▲▼ to select.
- 2) Press ▶ to set "ON" or "OFF."

If you select MOTION PICT. STATUS:

- "ON" → V-Chip Control is activated.
- "OFF" → V-Chip Control is deactivated.

2

```

----- LOCK -----
MOTION PICT. STATUS:OFF
CHANGE SETTINGS
TV PARENTAL STATUS :OFF
CHANGE SETTINGS

SELECT:▲▼KEY
SET :▶KEY
END :ACTION KEY
    
```

Select CHANGE SETTINGS.

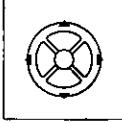

- 1) Press ▲▼ to select.
- 2) Press ▶ to display.

3

```

VIEW-NR PROGRAMS? : YES
G UNLOCKED
PG
PG-13
R
NC-17
X
CONTAINS NO RATING
SELECT:▲▼SET:▶
END :ACTION KEY
    
```

Select VIEW NR PROGRAMS?

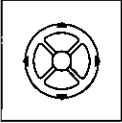

- 1) Press ▲▼ to select.
- 2) Press ▶ to set "YES" or "NO."

NR (Not Rated) PROGRAMS

Some movies, such as old movies or foreign movies usually have no ratings.

4

```

VIEW NR PROGRAMS? : YES
G UNLOCKED
PG
PG-13
R
NC-17
X
GENERAL AUDIENCE
SELECT:▲▼SET:▶
END :ACTION KEY
    
```

Select ratings to be blocked. (See right.)

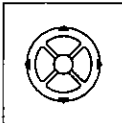

- 1) Press ▲▼ to select.
- 2) Press ▶ to set.

5

Redisplay LOCK menu to continue setup.

Press ACTION and go to page 34 (TV PARENTAL Ratings)

Or,
to exit, press ACTION four times.

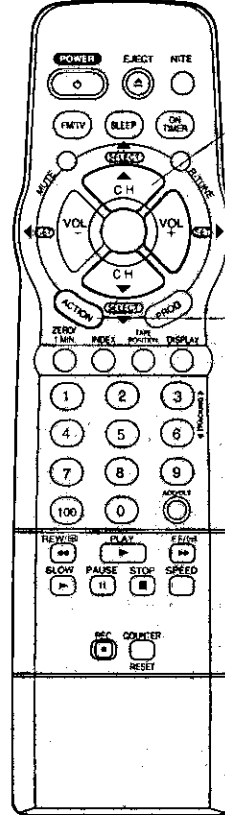

- 1 SELECT/SET
- 2 ▲:CH UP
- 3 ▼:CH DOWN
- 4 ▶:VOL UP
- 5 ACTION

MOTION PICTURE RATINGS

G	GENERAL AUDIENCE: All ages admitted.
PG	PARENTAL GUIDANCE: Some material may not be suitable for children.
PG-13	PARENTS CAUTIONED: Some material may be inappropriate for children under 13.
R	RESTRICTED: Under 17 requires accompanying parent or adult children.
NC-17	OVER AGE 17 ONLY: No one 17 and under admitted.
X	ADULTS ONLY:

V-Chip Control Feature

Setup TV PARENTAL Ratings

Process of V-Chip Control Feature

Enter Code → Setup → Blocking

If LOCK menu is not displayed, do "Enter Secret Code" steps on page 32.

1 Select TV PARENTAL STATUS.

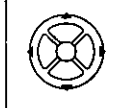
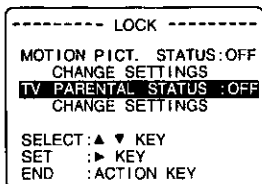

- 1) Press ▲▼ to select.
- 2) Press ▶ to set "ON" or "OFF."

If you select TV PARENTAL STATUS:

- "ON" → V-Chip Control is activated.
- "OFF" → V-Chip Control is deactivated.

2 Select CHANGE SETTINGS.

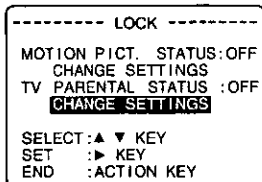

- 1) Press ▲▼ to select.
- 2) Press ▶ to display.

3 Select VIEW NR PROGRAMS?

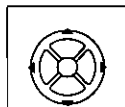
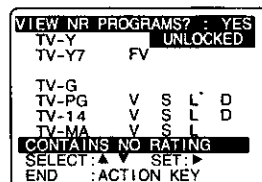

- 1) Press ▲▼ to select.
- 2) Press ▶ to set "YES" or "NO."

NR (Not Rated) PROGRAMS

Some TV shows, such as news, sports, weather, bulletins, emergency information usually have no ratings.

4 Select ratings to be blocked. (See next page.)

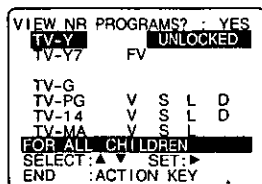

- 1) Repeatedly press ▲▼ to select.
- 2) Press ▶ to set.

- Ratings which are highlighted in GREEN will be blocked, when not highlighted (white letters), these will not be blocked.

Note

You may select from standard TV ratings (chart 1), or customize to a specific content rating (chart 2.)

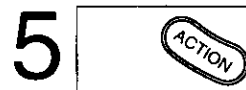

5 End setup.

Press ACTION four times.

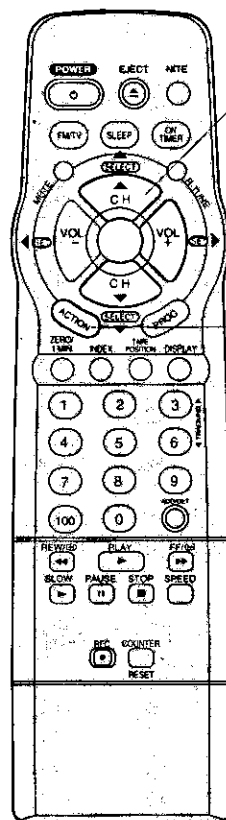

- 1 SELECT/SET
- 2 ▲:CH UP
- 3 ▼:CH DOWN
- 4 ▶:VOL UP
- 5 ACTION

**TV PARENTAL GUIDE RATINGS:
Chart 1**

TV-Y	FOR ALL CHILDREN: Content specifically geared to young viewers ages 2-8.
TV-Y7	FOR AGE 7 AND OLDER: May contain mild physical or comedic violence which may frighten children under 7.
TV-G	GENERAL AUDIENCE: Contains little or no violence, strong language, or sexual dialogue or situations.
TV-PG	PARENTAL GUIDANCE: May contain infrequent coarse language, limited violence, some suggestive sexual dialogue and situations.
TV-14	PARENTS CAUTIONED: May contain sophisticated themes, sexual situations, strong language, and more intense violence.
TV-MA	MATURE AUDIENCE: May contain mature themes, profane language, graphic violence, and sexual situations.

**TV PARENTAL GUIDE RATINGS:
Chart 2**

FV	Fantasy Violence
V	Violence
S	Sexual Situations
L	Adult language
D	Sexual Suggestive Dialog

Process of V-Chip Control Feature



Blocking Message

<When V-Chip Control is activated>

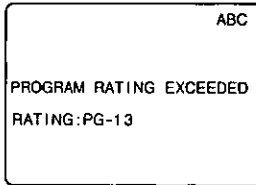

- If V-Chip Control is activated, and a program or movie exceeds the ratings you have set, a message will appear on a black background and sound is muted.

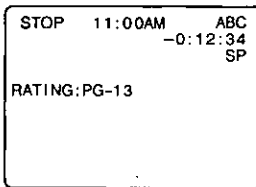

- If DISPLAY is pressed, even when V-Chip control is deactivated, rating is displayed on-screen.

To Continue Viewing a Blocked Program

After entering your 4 digit secret code, go to step 1 on both pages 33 and 34 and select "OFF" to deactivate V-Chip Control.

- The previous MOTION PICT. and TV PARENTAL settings will be restored.

Advanced Operation

Reset Language, Channels, Clock

Language

1

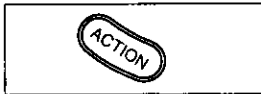

Display MAIN MENU.
Press ACTION.

2

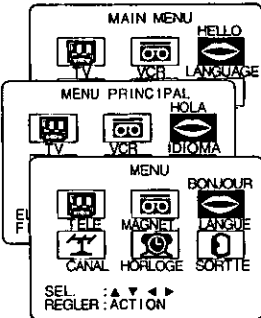

Select the language selection icon.

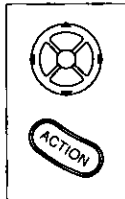

- 1) Press ▲▼◀▶ to select.
English:LANGUAGE
Spanish:IDIOMA
French:LANGUE
- 2) Press ACTION repeatedly to set.

3

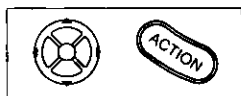

End setup.

- 1) Press ▲▼◀▶ to select "EXIT."
- 2) Press ACTION to exit.

Channels

a



Display MAIN MENU.
Press ACTION.

b

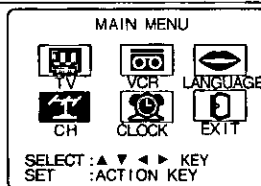

Display SET UP CH screen.

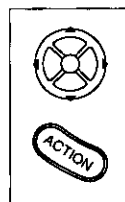

- 1) Press ▲▼◀▶ to select "CH."
- 2) Press ACTION to display.

c

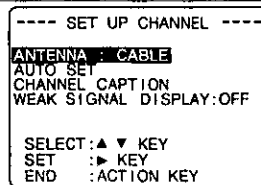

Select ANTENNA.

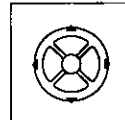

- 1) Press ▲▼ to select.
- 2) Press ▶ to select your antenna system ("TV" or "CABLE.")

d

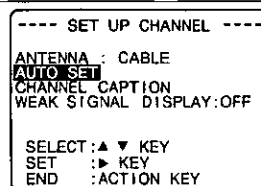

Select AUTO SET.

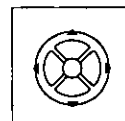

- 1) Press ▲▼ to select.
- 2) Press ▶ to start.

e



End setup.

Press ACTION twice.

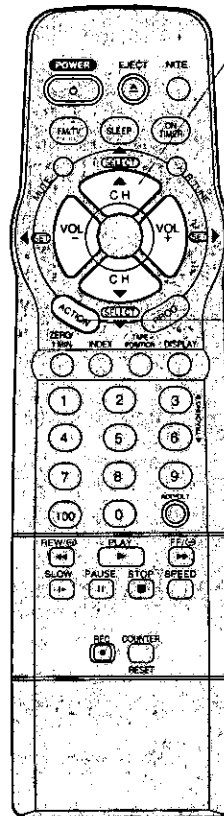

- 2 SELECT/SET
- 3 ▲:CH UP
- 4 ▼:CH DOWN
- 5 ▶:VOL UP
- ▶:VOL DOWN
- a
- b
- c
- d
- 1 ACTION
- 2
- 3
- a
- b
- e

Clock

1



Display MAIN MENU.
Press ACTION.

2

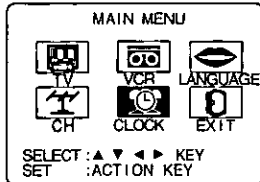

Display SET CLOCK screen.

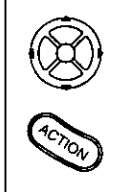

1) Press ▲▼◀▶ to select "CLOCK."
2) Press ACTION.

3

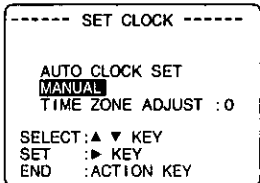

Display MANUAL screen.

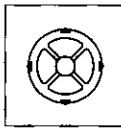

1) Press ▲▼ to select "MANUAL."
2) Press ▶ to set.

• For Auto Clock Set, select "AUTO CLOCK SET" then press ▶ to set and CH▲ to start.

4

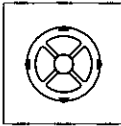
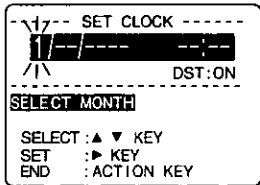

Set the clock manually.

1) Press ▲▼ to select the month.
2) Press ▶ to set.

• Likewise set date, year, time, and DST. (Daylight Saving Time.)

To Make Corrections, repeatedly press ◀▶ to move to error, then correct.

5



End setup.
Press ACTION twice to start the clock and exit this mode.

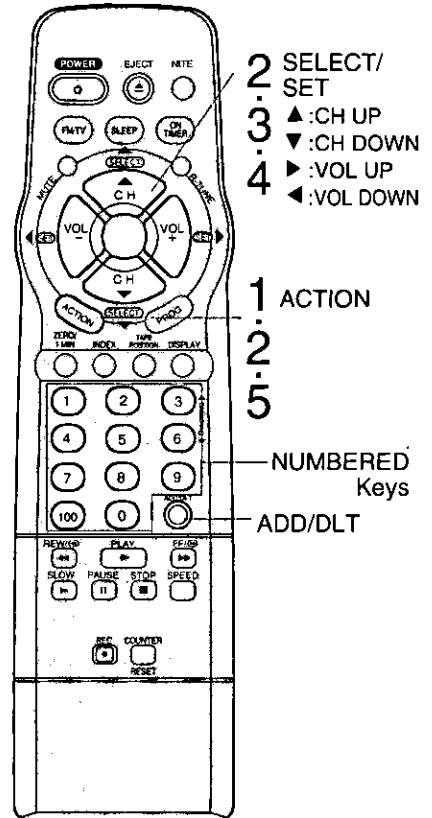

Add or Delete a Channel

To add channel:
Select channel with NUMBERED keys and press ADD/DLT.

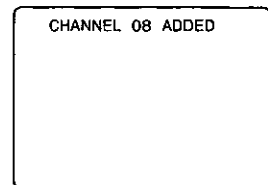

To delete channel:
Select channel with CH▲▼ or NUMBERED keys and press ADD/DLT.

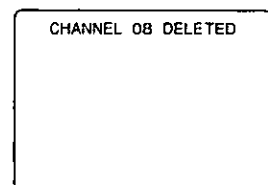

On-Screen Displays (OSD)

VCR Status & Clock Display

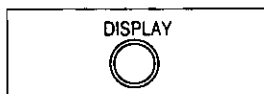

To display or remove the overlay.
Press DISPLAY.

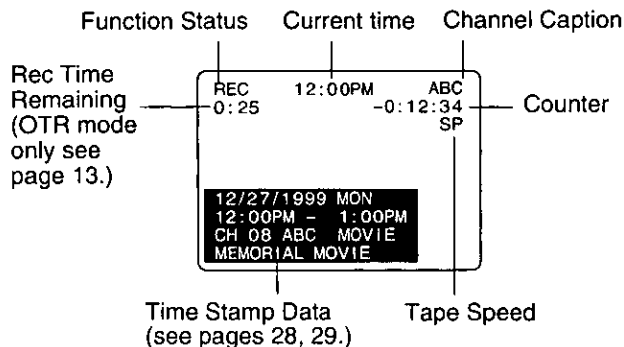

Channel & Function Display

When a function button is pressed (PLAY, FF, etc.) or you change channels, the Combination VCR mode or channel number will be displayed.
(Some station names may also appear if Channel Caption is set. See pages 26, 27.)

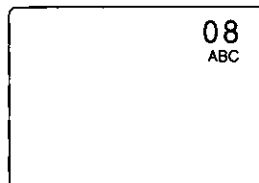

Blue Screen Display

Whenever a blank section of a tape comes up in Play mode, or when the selected channel has no broadcast signal with the "Weak Signal Display ON/OFF" (page 30) set to "OFF," the TV screen will turn solid blue.

Dew Detection System

To prevent damage to your tapes, this unit is equipped with a dew detection system. When moisture condensation is detected inside the Combination VCR, "DEW" will appear on-screen for a few seconds. If a tape is inserted, it will be ejected. Also, VCR functions will be non-operational until dew condition passes. Press DISPLAY to see if dew condition still exists. In order to avoid this condition, try not to move the unit directly from a cold place to a warm place. TV functions are not affected.

Warning and Instruction Displays

These displays will alert you of a missed operation or provide further instructions.

OSD	Caution	Pg	OSD	Caution	Pg
NO CH FOUND PLEASE CHECK ANTENNA CABLE CONNECTION THEN PUSH CH UP KEY AGAIN	If no active channels are found for CHANNEL MEMORY...	6	NO CASSETTE PLEASE INSERT A CASSETTE	If you press PLAY, FF, REW, or REC on the remote control or the Combination VCR without a cassette inserted...	12 13
PLEASE SET CLOCK BEFORE PROGRAMMING	If you attempt to set or review a Timer Recording or set the On-Timer and the Clock is not set...	8 9 37	DEW	If moisture condensation is detected inside the Combination VCR...	38
CHECK CASSETTE RECORD TAB	If you press REC on the remote control or the Combination VCR, and a cassette is inserted with no record tab...	4 13	VIDEO HEADS MAY NEED CLEANING PLEASE INSERT HEAD CLEANING CASSETTE OR REFER TO MANUAL END: PLAY KEY	If head cleaning becomes necessary while playing back a tape...	5
TO CANCEL TIMER REC HOLD DOWN STOP KEY FOR APPROX 3 SEC	If you press STOP during a Timer Recording...	15	VCR LOCK ACTIVATED	If you press a function button other than STOP/EJECT or POWER while the Combination VCR is in VCR Lock mode...	30

Operation Differences Using AC or DC Power

This Combination VCR is equipped to be operated on either AC or DC power. However, there are some differences in Combination VCR operation depending on which power supply is used.

Notes

- The Combination VCR will accept commands from the remote control only when POWER on the Combination VCR is turned ON (POWER indicator is lit.)
- When POWER on the Combination VCR is OFF (DC power source), it's the same as if the Combination VCR were unplugged. Therefore, all memory data, i.e. clock data, etc. is erased in approximately one minute.
- If there is a loss in battery voltage of more than 30 seconds, the Combination VCR automatically shuts off. When normal voltage is restored, pressed POWER on the Combination VCR OFF and then ON.

AC Power Supply is Used Power Switch is ON on the Unit	DC Power Supply is Used Power Switch is ON on the Unit
<ul style="list-style-type: none"> • If POWER on the remote control is pressed OFF during rewind, the power will shut off but the rewind will continue (Memory Rewind.) If it is pressed during recording, the recording will continue. 	<ul style="list-style-type: none"> • If POWER on the remote control is pressed OFF during rewind, the rewind is terminated and the Combination VCR shuts off. If it is pressed while recording, the recording is terminated and the Combination VCR shuts off.
<ul style="list-style-type: none"> • It takes from 3 to 5 minutes to rewind a two hour tape. 	<ul style="list-style-type: none"> • It takes 5 minutes to rewind a two hour tape.
<ul style="list-style-type: none"> • When STOP is pressed, the cylinder continues to rotate for 5 minutes. 	<ul style="list-style-type: none"> • When STOP is pressed, the cylinder stops.
<ul style="list-style-type: none"> • The search speed in SLP mode is 21 times normal. 	<ul style="list-style-type: none"> • The search speed in SLP mode is 21 times normal.
<ul style="list-style-type: none"> • If the AC cord is unplugged and then plugged back in, the Combination VCR will be in OFF condition. 	<ul style="list-style-type: none"> • If POWER on the Combination VCR is pressed OFF, the Combination VCR will be in Stop mode when turned back on. • If the DC cord is unplugged, and then plugged back in; <u>within one minute</u>, Play and Rec mode will continue. All other functions will change to Stop mode. If unplugged for <u>over one minute</u>, the Combination VCR will be in STOP mode when plugged back in.
AC Power Supply is Used	DC Power Supply is Used
<ul style="list-style-type: none"> • If POWER on the Combination VCR is pressed OFF, OTR (One Touch Recording) is continued. 	<ul style="list-style-type: none"> • If POWER on the Combination VCR is pressed OFF, OTR (One Touch Recording) will be cancelled.
<ul style="list-style-type: none"> • If POWER on the Combination VCR is pressed OFF, Timer Recording will be performed. 	<ul style="list-style-type: none"> • If POWER on the Combination VCR is pressed OFF, while a Timer Recording is in progress, the Timer Recording will be cancelled.
<ul style="list-style-type: none"> • If POWER on the Combination VCR is pressed OFF during rewind, the power will shut off but the rewind will continue (Memory Rewind.) 	<ul style="list-style-type: none"> • If POWER on the Combination VCR is pressed OFF during rewind, the rewind is terminated and the Combination VCR shuts off.

WARNING:

- There may be an excessive drain on the battery if the Combination VCR is used along with, such power consuming things as fog lamps, air conditioner, power windows, etc.
- Never watch or operate the Combination VCR while driving a vehicle.
- Avoid leaving the Combination VCR in places of extreme heat, such as inside a hot vehicle, or in direct sunlight as this may damage the Combination VCR.

Before Requesting Service

Check the following points once again if you are having trouble with your Combination VCR.

Power	Correction
No power...	<ul style="list-style-type: none"> • Completely insert Power Plug into an AC outlet or when using the DC Car Battery cord, check to see if the fuse is blown. • Set POWER button to ON.
Monitor	Correction
No picture or sound...	<ul style="list-style-type: none"> • Make sure your antenna system (TV or CABLE), is correctly set. (P. 6) • Completely insert Power Plug into an AC outlet. (Or use the DC Car Battery Cord.) • Check that POWER button is set to on.
Poor picture with normal sound...	<ul style="list-style-type: none"> • Adjust BRIGHTNESS, SHARPNESS, and PICTURE controls in the SET UP TV menu. (P.11)
Poor sound with normal picture...	<ul style="list-style-type: none"> • Adjust VOLUME control. (P.10)
Poor TV reception...	<ul style="list-style-type: none"> • Adjust SHARPNESS and PICTURE controls in the SET UP TV menu. (P.11)
No color or poor color...	<ul style="list-style-type: none"> • Adjust TINT and COLOR controls in the SET UP TV menu. (P.11)
Ghost (multiple) images...	<ul style="list-style-type: none"> • Install a directional antenna.
TV programs cannot be watched...	<ul style="list-style-type: none"> • Make sure that the channel being received is in the Combination VCR's memory. (P. 36)
Channel cannot be selected...	<ul style="list-style-type: none"> • The design of this unit is such that only the channel being recorded can be viewed.
VCR	Correction
TV program cannot be recorded...	<ul style="list-style-type: none"> • Make sure your antenna system (TV or CABLE), is correctly set. (P. 6) • Make sure cassette record tab is intact. (P. 4)
Timer recording cannot be performed...	<ul style="list-style-type: none"> • Check clock is set to current time and date. • Make sure DSS/CABLE box (if used) is left on and tuned to channel to be recorded. • Set recording Start/Stop time correctly. (P.14-15) • Timer recording may not be performed or continued if a power interruption of more than 1 minute occurs before or during a Timer Recording, after power is restored.
No playback picture, or the playback picture is noisy or contains streaks...	<ul style="list-style-type: none"> • Adjust TRACKING control in either direction. (P.12) • Try Head Cleaning. (P.5)
VCR cannot be controlled...	<ul style="list-style-type: none"> • Make sure VCR LOCK is set to off. (P. 30) • Make sure unit is not in a Timer Record operation.
Remote Control	Correction
Combination VCR cannot be controlled...	<ul style="list-style-type: none"> • Aim Remote directly at the remote sensor on the Combination VCR. (P. 47) • Avoid any object blocking signal path. • Inspect the remote batteries. (P. 4) • Make sure VCR LOCK is set to off. (P. 30) • Exposing Combination VCR remote sensor to direct fluorescent or outdoor light may cause signal interference.
Miscellaneous	Correction
Video cassette cannot be inserted...	<ul style="list-style-type: none"> • Insert the cassette window side up; record tab facing you.
Video cassette cannot be removed...	<ul style="list-style-type: none"> • Completely insert Power Plug into an AC outlet. (Or use the DC Car Battery Cord.)
Eject does not function or insertion cannot be done...	<ul style="list-style-type: none"> • Turn the POWER off and then on, and try ejecting or inserting the tape again.
Video cassette ejects when a recording is started, or the power is turned off for timer recording...	<ul style="list-style-type: none"> • Make sure cassette record tab is intact. (P. 4)
In stop mode, the VCR motor (CYLINDER) continues to rotate...	<ul style="list-style-type: none"> • To enable Quick Play mechanism, the VCR cylinder will rotate for about 5 minutes. This reduces response time from Stop to Play mode and from Play to Rewind Search mode.
VCR cannot be controlled...	<ul style="list-style-type: none"> • Make sure VCR LOCK is set to off. (P. 30)

If you cannot resolve the problem, please call the Customer Satisfaction Center for product assistance at 201-348-9090.

To locate an authorized servicer call toll free 1-800-211-PANA(7262.)

Service Center List

For Product Information, Operating Assistance, Literature Request, Dealer Locations, and all Customer Service inquiries please contact:

1-800-211-PANA (7262), Monday-Friday 9 am-9 pm Saturday-Sunday 9 am-7 pm, EST.

Web Site: <http://www.panasonic.com>

You can purchase parts, accessories or locate your nearest servicer by visiting our Web Site.

Accessory Purchases:

1-800-332-5368 (Customer Orders Only)

Panasonic Services Company 20421 84th Avenue South, Kent, WA 98032

(6 am to 5 pm Monday-Friday; 6 am to 10:30 am Saturday; PST)

(Visa, MasterCard, Discover Card, American Express, Check)

Factory Servicenters Locations

CALIFORNIA

6550 Katella Avenue
Cypress, CA 90630

800 Dubuque Avenue
S. San Francisco,
CA 94080

20201 Sherman Way
Suite 102
Canoga Park, CA
91306

3878 Ruffin Road
Suite A
San Diego, CA 92123

COLORADO

1640 South Abilene
Street
Suite D
Aurora, CO 80012

FLORIDA

3700 North 29th Avenue
Suite 102
Hollywood, FL 33020

GEORGIA

8655 Roswell Road
Suite 100
Atlanta, GA 30350

ILLINOIS

9060 Golf Road
Niles, IL 60714

1703 North Randall
Road Elgin, IL 60123
(Pick-up/Drop-off only)

MARYLAND

62 Mountain Road
Glen Burnie, MD 21061

MASSACHUSETTS

60 Glacier Drive,
Suite G
Westwood, MA 02090

MICHIGAN

37048 Van Dyke
Avenue
Sterling Heights,
MI 48312

MINNESOTA

7850-12th Avenue South
Airport Business Center
Bloomington, MN 55425

OHIO

2236 Waycross Road
Civic Center Plaza
Forest Park, OH 45240

PENNSYLVANIA

2221 Cabot Blvd West
Suite B
Langhorne, PA 19047

Chartiers Valley
Shopping Center
1025 Washington Pike
Bridgeville, PA 15017

TENNESSEE

3800 Ezell Road Suite
806
Nashville, TN 37211

TEXAS

7482 Harwin Drive
Houston, TX 77036

13615 Welch Road
Suite 101
Farmers Branch,
TX 75244

WASHINGTON

20425-84th Avenue
South Kent, WA 98032

HAWAII

99-859 Iwaiwa Street
Aiea, Hawaii 96701
Phone (808) 488-1996
Fax (808) 486-4369

Service in Puerto Rico

Matsushita Electric of Puerto Rico, Inc. Panasonic Sales Company/Factory Servicer:

Ave, 65 de Infanteria, Km. 9.5, San Gabriel Industrial Park, Carolina, Puerto Rico 00985

Phone (787) 750-4300

Fax (787) 768-2910

Conexión de la antena externa

Desenganche la antena del televisor o de la videograbadora que tuviera anteriormente y conéctela a la parte trasera del registrador Combinación de VCR/TV, como se muestra en el diagrama. Si el sistema de su antena tiene conductores UHF y VHF separados, usted necesita un mezclador de banda UHF/VHF (no viene con el equipo.)

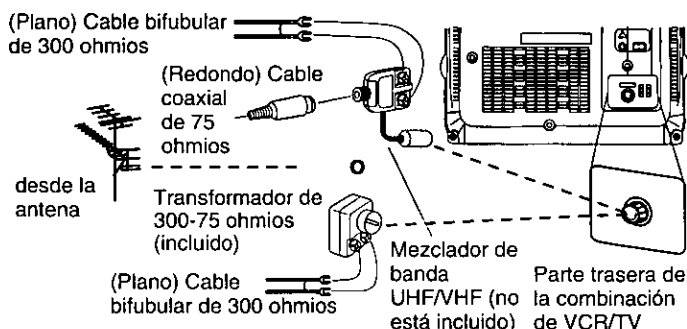

Conexiones de TV cable

■ Sin un decodificador de TV cable

Podrá;

- grabar o ver canales sin codificar.

No Podrá;

- grabar o ver canales codificados.
- ver otro canal que no sea el seleccionado para cualquier tipo de grabación.

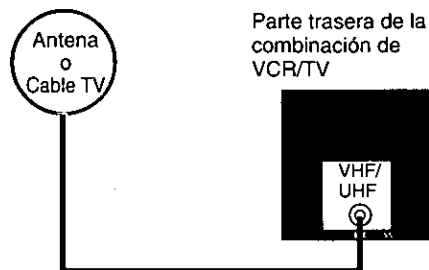

■ Con un decodificador de TV cable

Podrá;

- grabar o ver cualquier canal incluso los canales codificados.

NOTA:

El canal deberá ser seleccionado en el decodificador de TV cable.

No Podrá;

- ver otro canal que no sea el seleccionado para cualquier tipo de grabación.
- hacer una grabación con temporizador de un canal a menos que lo seleccione en el decodificador de TV cable.

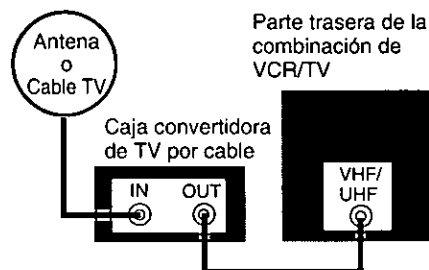

Para ver y grabar un canal codificado/ no codificado

Sintonice el canal del Registrador de la combinación de VCR/TV en el canal de salida de la caja convertidora de televisión por cable (por ejemplo el canal 3.)

Después, seleccione en el decodificador de TV cable el canal que se quiera ver o grabar.

■ Con un receptor DSS

Podrá;

- grabar o ver cualquier canal incluso los canales codificados.

NOTA:

El canal deberá ser seleccionado en el receptor DSS.

No Podrá;

- ver otro canal que no sea el seleccionado para cualquier tipo de grabación.
- hacer una grabación con temporizador de un canal a menos que lo seleccione en el receptor DSS.

NOTA:

El receptor DSS debe estar apagado para ver programas desde un decodificador de TV cable o desde la antena. Consulte el manual del receptor DSS para más detalles.

DSS es una marca registrada de DIRECTTV, INC., una unidad de GM Hughes Electronics.

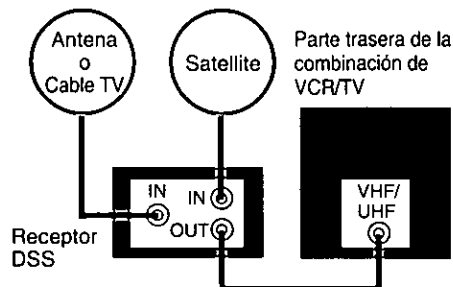

Conexión de la Antena Interior

Inserte la antena varilla (suministrada) en el receptáculo de la parte trasera de la combinación de VCR/TV. Luego, conecte los dos alambres del transformador de 300 ohmios-75 ohmios (suministrado.)

Entonces, conecte el transformador a la parte trasera de la combinación de VCR/TV como se muestra. Ahora, despliegue la antena y ajuste su longitud, dirección y ángulo para la más clara imagen.

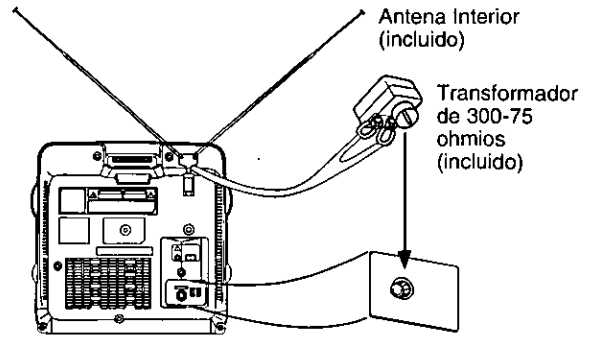

Conexión a la fuente de alimentación

Ud. podrá llevar su combinación de VCR/TV a donde ud. va con dos diferentes formas de alimentación. Ud. podrá conectar su cable de C.A. (corriente alterna) incorporado a cualquier fuente de CA. Cuando está viajando, conecte su cable para batería de coche al enchufe de su encendedor de cigarrillo.

para su seguridad de uso y para evitar daños al aparato, por favor siga las instrucciones y conexiones con cuidado.

■ Conexión del cable de CA (incorporado)

1. Conecte el cable de CA incorporado al enchufe de entrada CA en la parte trasera del aparato como está demostrado.
2. Conecte el cable de CA al enchufe de CA su pared.

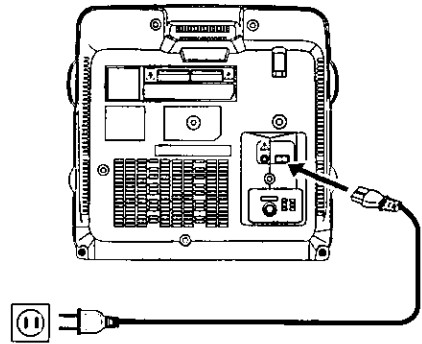

■ Conexión del cable para la batería de coche (incorporado)

1. Conecte el cable para batería de coche al enchufe de entrada CC en la parte trasera del aparato como está demostrado.
2. Arranque su vehículo.
 - No conecte su cable al enchufe del encendedor de cigarrillo antes de arrancar su vehículo.
3. Desconecte el encendedor de cigarrillo y conecte el enchufe de su cable para batería.

NOTAS IMPORTANTES:

- Este cable sólo se puede usar en vehículos con batería de 12V o 24V (toma a tierra negativo.) Verifique en su manual de instrucciones de su vehículo.
- Use solamente el cable para batería de coche incorporado con su combinación de VCR/TV.
- Para evitar la disminución del voltage, no extienda el cable para batería de coche desde usando otro cable de extensión.
- Cuando no está usando el aparato, desconecte el cable para batería de coche desde el enchufe del encendedor para cigarrillo para evitar la descarga de la batería de su automóvil.

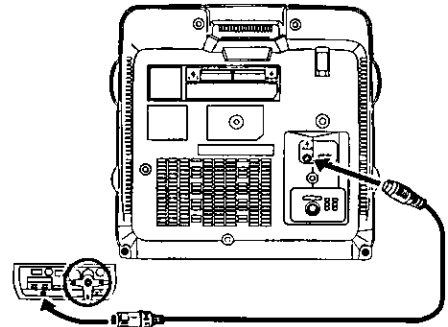

■ Cambio del fusible de cable para

Si su fusible de seguridad se ha cortado, cambie como sigue al siguiente.

1. Destornille la tapa.
2. Cambie su fusible con otro fusible de 125V 10A.
 - Use sólo fusibles con las especificaciones correctas.
3. Reponga la tapa.

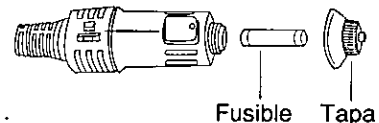

Para fijar el idioma, canal y reloj

1 Presione **POWER** para encender el videograbador combinado.

2 **SELECT LANGUAGE**
 PUSH CH ▲ : English
 OPRIMIR CH ▼ : Español
 APP. VOL + : Français

Seleccione el lenguaje.
 CH ▲ : para inglés
 CH ▼ : para español
 VOL+ : para francés

3 **FIJACION AUTO. (CA/RELOJ)**
 CONECTE EL CABLE DE LA ANTENA Y SI ESTA USANDO UNA CAJA DE TV POR CABLE SINTONICE AL CANAL PBS DE SU LOCAL LUEGO...
 POR FAVOR OPRIMIR CH UP

Comience el ajuste automático de canales y el ajuste automático del reloj.
 Presione CH ▲.

Las siguientes informaciones aparecerán seguidamente:

- AUTOPROGRAMACION EN PROCESO
- AUTOPROGRAMACION COMPLETO
- FIJACION AUTOMATICA DEL RELOJ EN PROCESO

Caso 1

7/28/1999 MAR 12:00PM
 HORA VERANIEGA: ACT
 CANAL FIJADO : CA 10
 FIJACION AUTOMATICA
 COMPLETO
 TERMINAR : OPRIMIR CH UP

(Ajuste terminado)
 Presione CH ▲ para salir.

- Si la hora exhibida no es la correcta para su zona, ajuste el reloj nuevamente de acuerdo con la sección "Ajuste de la zona horaria" en la siguiente página.

Caso 2

FIJACION AUTOMATICA DEL RELOJ ES INCOMPLETO
 OPRIMIR ACTION PARA FIJAR EL RELOJ

(Ajuste sin terminar)

NOTA IMPORTANTE PARA AJUSTE AUTOMATICO DEL RELOJ

- El ajuste automático del reloj será realizado al volver a encender el videograbador combinado cada vez que lo apague. Si usa un decodificador de TV cable y desea que la función de ajuste automático del reloj funcione, el decodificador de TV cable debe quedar encendido y sintonizando el canal PBS en el momento en que se apaga el videograbador combinado.
- Si usa un sintonizador de TV satelital, para que funcione el ajuste automático del reloj, debe de estar apagado.
- Si usa un toma de audio/video para conectar el videograbador combinado y el decodificador de TV cable o el sintonizador de TV satelital, deberá también conectar el cable coaxial RF para poder usar las funciones de ajuste automático de reloj y ajuste automático de canal.
- Si por cualquier razón se cambiara la hora manualmente, no se podrá realizar la corrección automática de la hora.

Caso 1 Ajuste de la zona horaria.

a Exhiba el **MENU PRINCIPAL**.
 Presione **ACTION**.

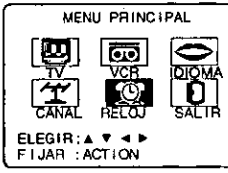
b **MENU PRINCIPAL**

 ELEGIR: ▲ ▼ ◀ ▶
 FIJAR : ACTION

Exhiba la pantalla "FIJAR RELOJ".
 1) Presione ▲▼◀▶ para seleccionar "RELOJ."
 2) Presione **ACTION** para exhibirla.

c **FIJAR RELOJ**
 FIJACION AUTOMATICA MANUAL
 AJUSTE ZONA HORA : 0
 ELEGIR: ▲ ▼
 FIJAR : ◀ ▶
 TERMINAR: ACTION

Seleccione "AJUSTE ZONA HORA."
 1) Presione ▲▼ para seleccionar.
 2) Presione ◀▶ para ajustar.

d **Final del ajuste.**
 Presione **ACTION** dos veces.
 • El valor numérico ajustado aquí se vuelve "0" una vez que ajuste manualmente el reloj.

Caso 2 El ajuste del reloj es incompleto. Ajuste el reloj manualmente.

A **FIJACION AUTOMATICA DEL RELOJ ES INCOMPLETO**
 OPRIMIR ACTION PARA FIJAR EL RELOJ

Exhiba la pantalla **FIJAR RELOJ**.
 Presione **ACTION** para salir de este modo.

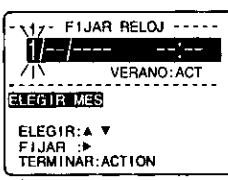
B **FIJAR RELOJ**

 ELEGIR MES
 ELEGIR: ▲ ▼
 FIJAR : ▶
 TERMINAR: ACTION

Ajuste el reloj manualmente.
 1) Presione ▲▼ para seleccionar el mes.
 2) Presione ▶ para ajustar.

- De la misma manera, ajuste el día, el año, la hora y la hora de ahorro de energía. (VERANO)

Para hacer correcciones, presione repetidamente ◀▶ para moverse hasta el error, luego corríjalo.

C **Final del ajuste.**
 Presione dos veces **ACTION**.

Para fijar o fijar de nuevo el reloj

En caso de que el reloj es incorrecto o ha ocurrido un corte eléctrico.

- 1 Oprima **ACTION** para que parezca el **MENU PRINCIPAL**.
- 2 Oprima ▲▼◀▶ para elegir "RELOJ". Luego, oprima **ACTION** para que aparezca la pantalla de la **FIJAR RELOJ**.
- 3 Oprima ▲▼ para elegir "MANUAL", y luego ▶ para que aparezca la pantalla de la **FIJAR RELOJ**.
- 4 Por favor continúe con los pasos **B** y **C** de la instrucción anterior (Caso 2.)

Operaciones básicas para la reproducción

- 1 Inserte un casete.**
 - El videograbador combinado se enciende automáticamente.
 - 2 Presione PLAY.**
 - La reproducción comienza automáticamente si el casete no tiene la lengüeta para prevención de grabación.
- Para encontrar una escena en particular
Búsqueda hacia adelante → Presione FF
Búsqueda hacia atrás → Presione REW
 - Para ver en cámara lenta → Presione SLOW
 - Para ver una imagen fija (congelada) → Presione PAUSE
 - Para ver imágenes cuadro a cuadro → Presione SLOW en el modo de imagen fija.
 - Para parar → Presione STOP
 - Para rebobinar la cinta → Presione REW
 - Para expulsar la cinta → Presione EJECT en el control remoto o STOP/EJECT en el videograbador combinado.

Operaciones básicas para la grabación

- 1 Inserte un casete con la lengüeta para prevención de grabado.**
 - El videograbador combinado se enciende automáticamente.
- 2 Seleccione el canal.**

Presione CH ▲▼ o las teclas numéricas correspondiente.
- 3 Seleccione la velocidad de grabación.**

Presione SPEED.
SP = reproducción normal
LP = reproducción larga
SLP = reproducción super larga

 - La velocidad seleccionada debe aparecer en la pantalla.
- 4 Comience la grabación.**

Presione REC.

 - Para editar partes no deseadas de una grabación, presione PAUSE para hacer una pausa durante la grabación.
 - No podrá ver otro canal durante la grabación.
 - Para parar → Presione STOP.
 - El videograbador combinado deja de grabar a una hora prefijada. (Grabación de un toque) Presione REC repetidamente para ajustar la hora de grabación (30 min - 4 horas.)

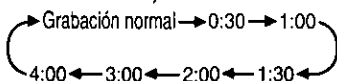

Grabación con temporizador

- 1 Exhiba FIJAR PROGRAMACION.**

Presione PROG.

 - Si ya existe un programa en la memoria, presione ▲▼ y ► para seleccionar un número de programa sin usar.

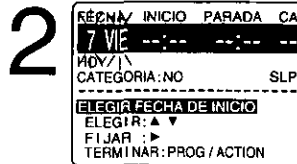

Ajuste la fecha de grabación.

- 1) Presione ▲▼ para seleccionar.
- 2) Presione ► o ◀ para ajustar.

- 1 - 31 = Grabación única
- DIARIO = a la misma hora de lunes a viernes
- SEMANAL = a la misma hora una vez a la semana

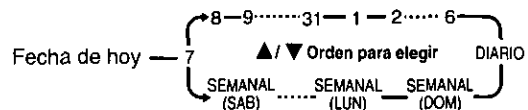

Repita el paso 2 para ajustar:
hora de comienzo, hora de parada, canal (o LINEA para una fuente exterior), categoría [N/O (no aplicable), DEPORTE, CINE, COMEDIA, MUSICA, DRAMA], velocidad (SP, LP, SLP)

- 3 Haga las anotaciones necesarias.**
 - Si no fueran necesarias, vaya al paso 4.
- 1) Presione ▲ para hacerlas.
 - 2) Presione ▲▼ para seleccionar.
 - Los caracteres cambiarán en el siguiente orden.

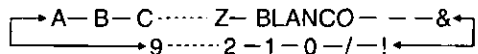

- 3) Presione ► o ◀ para ajustar.
- 4) Presione PROG (o ACTION) para finalizar.

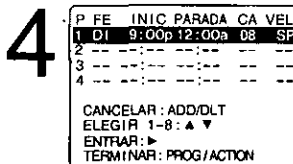

Termine el programa.

Presione PROG (o ACTION.)
Para introducir más programas.
presione ▲▼ y ► para seleccionar y ajustar el número de programa en blanco, y luego repita los pasos 2 y 3.

- 5 Salga de este modo.**

Presione PROG (o ACTION.)

 - Si está usando un decodificador de TV cable, asegúrese que se encuentra en el canal deseado y que la alimentación queda conectada para grabar con temporizador.
 - El indicador PROG TIMER se enciende en el videograbador combinado.

Location of Controls

Remote Control Buttons

Tower Remote Control

EJECT button:

When EJECT is pressed, the tape is ejected from Cassette Compartment.

If EJECT is pressed during recording, the Combination VCR will not respond to the command.

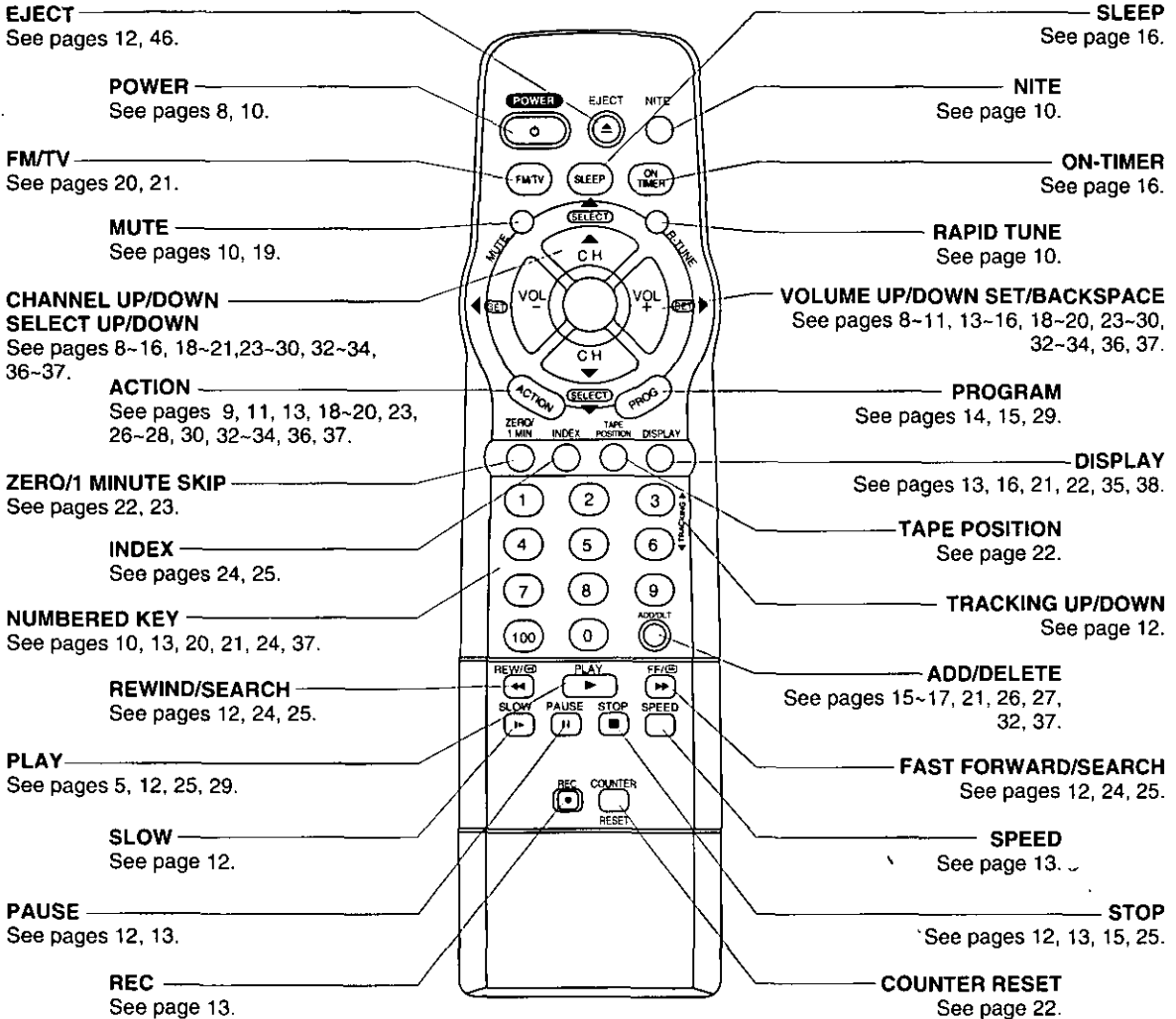

Kitchen (Easy-Find™) Remote Control <Model PV-M949W only>

- This remote control has a magnet on the back so you can stick it to your refrigerator, etc. for convenience.
- The Kitchen remote control buttons work the same as the above remote control.

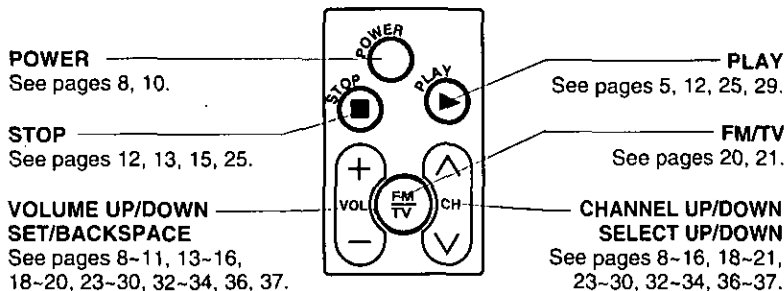

Front View of the Combination VCR and Indicators on the Front Panel

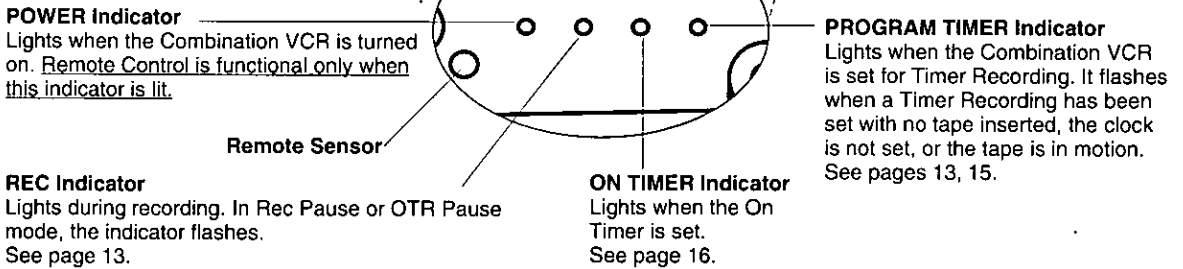
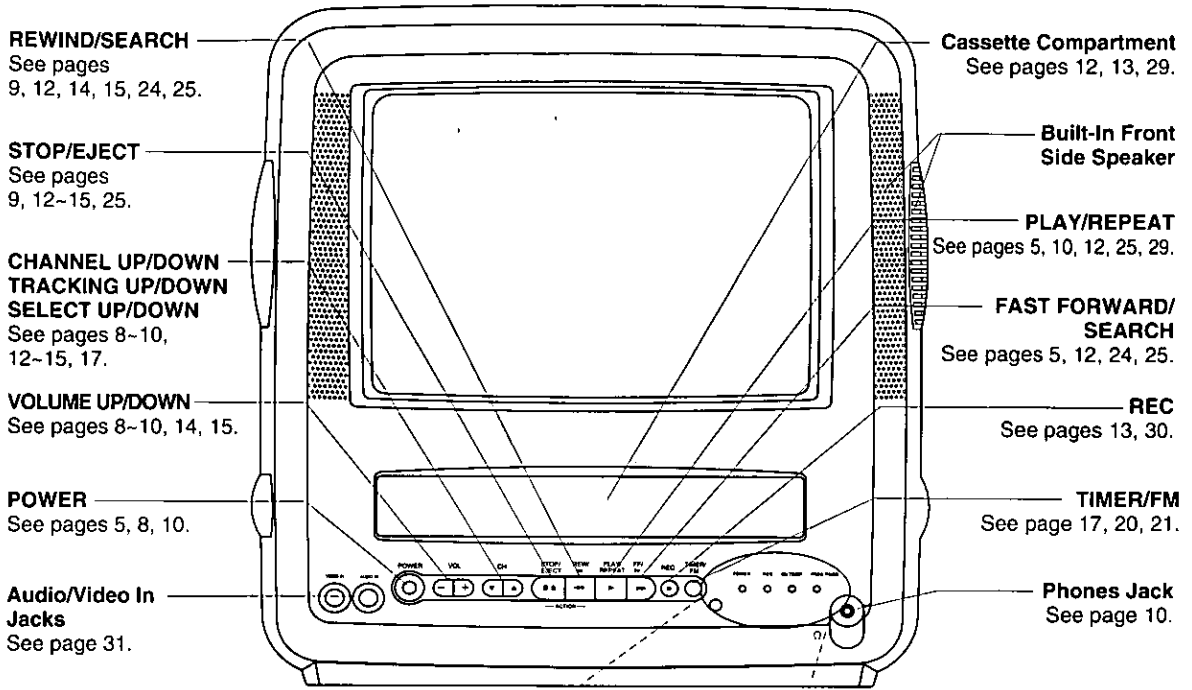

Rear View of the Combination VCR

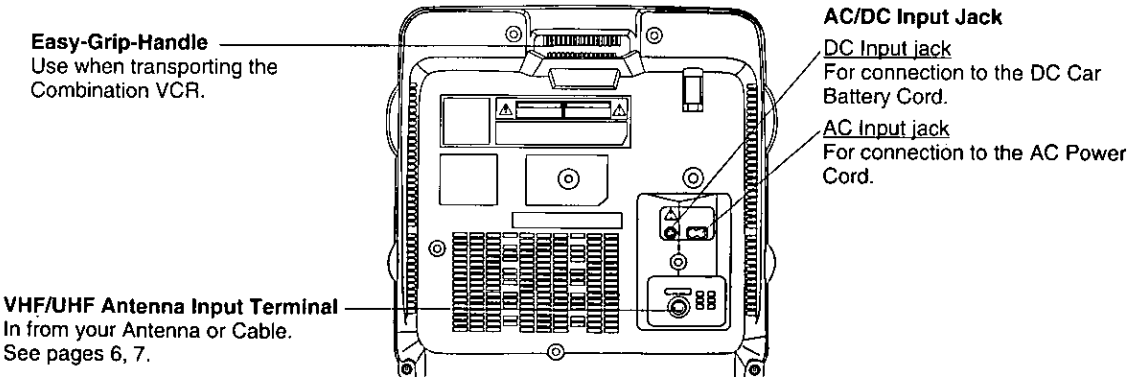

Warranty

Panasonic Consumer Electronics Company,
Division of Matsushita Electric Corporation of America,
One Panasonic Way
Secaucus, New Jersey 07094

Panasonic Sales Company,
Division of Matsushita Electric of Puerto Rico, Inc.
AVE. 65 de Infantería, Km. 9.5 San Gabriel
Industrial Park Carolina, Puerto Rico 00985

Panasonic Video Products Limited Warranty

Panasonic Consumer Electronics Company or Panasonic Sales Company (collectively referred to as "the Warrantor") will repair this product with new or refurbished parts, free of charge, in the USA or Puerto Rico, in the event of a defect in materials or workmanship as follows (all time periods commence from the date of the original purchase):

<u>PRODUCT</u>	<u>PARTS</u>	<u>LABOR</u>
CAMCORDER	ONE (1) YEAR, EXCEPT CCD IMAGE SENSOR CCD IMAGE SENSOR - SIX(6)MONTHS	NINETY (90) DAYS NINETY (90) DAYS
VCR	ONE (1) YEAR	NINETY (90) DAYS
A/V MIXER	ONE (1) YEAR	NINETY (90) DAYS
MONITOR-VCR	ONE (1) YEAR, EXCEPT CRT CRT - TWO (2) YEARS	NINETY (90) DAYS CRT - NINETY (90) DAYS CUSTOMER PAYS ALL LABOR CHARGES AFTER 90 DAYS

Monitor-VCR In-home or carry-in Service: 22" (diagonal) CRT / LCD and Larger

Monitor-VCR Carry-in Service: 21" (diagonal) CRT / LCD and smaller

Batteries (if included) - New rechargeable batteries in exchange for defective rechargeable batteries for ten (10) days. Non-rechargeable batteries are not warranted.

Tape (if included) - New video cassette tape in exchange for a defective video cassette tape for five (5) days.

In-home, carry-in or mail-in service, as applicable, in the USA can be obtained during the warranty period by contacting a Panasonic Services Company (PASC) Factory Servicenter listed in the Service Directory. Or call toll free 1-800-211-PANA(7262), to locate an authorized PASC Servicenter. Carry-in or mail-in service in Puerto Rico can be obtained during the warranty period by calling the Panasonic Sales Company telephone number listed in the Servicenter Directory.

This warranty is extended only to the original purchaser. A purchase receipt or other proof of the date of the original purchase is required before warranty service is rendered.

This warranty only covers failures due to defects in materials and workmanship which occur during normal use and does not cover normal maintenance, including, but not limited to, video and audio head cleaning. The warranty does not cover damage which occurs in shipment, or failures which are caused by products not supplied by the warrantor, or failures which result from accident, misuse, abuse, neglect, mishandling, misapplication, alteration, modification, faulty installation, set-up adjustments, improper antenna, inadequate signal pickup, maladjustment of consumer controls, improper operation, power line surge, improper voltage supply, lightning damage, commercial use such as hotel, office, restaurant, or other business or rental use of the product, or service by anyone other than a PASC Factory Servicenter or a PASC authorized Servicenter, or damage that is attributable to acts of God.

LIMITS AND EXCLUSIONS

There are no express warranties except as listed above.

THE WARRANTOR SHALL NOT BE LIABLE FOR INCIDENTAL OR CONSEQUENTIAL DAMAGES (INCLUDING, WITHOUT LIMITATION, DAMAGE TO TAPES) RESULTING FROM THE USE OF THIS PRODUCTS, OR ARISING OUT OF ANY BREACH OF THE WARRANTY. ALL EXPRESS AND IMPLIED WARRANTIES, INCLUDING THE WARRANTIES OF MERCHANTABILITY AND FITNESS FOR PARTICULAR PURPOSE, ARE LIMITED TO THE APPLICABLE WARRANTY PERIOD SET FORTH ABOVE.

Some states do not allow the exclusion or limitation of incidental or consequential damages, or limitations on how long an implied warranty lasts, so the above exclusions or limitations may not apply to you.

This warranty gives you specific legal rights and you may also have other rights which vary from state to state.

If a problem with this product develops during or after the warranty period, you may contact your dealer or Servicenter. If the problem is not handled to your satisfaction, then write to the Customer Satisfaction Center at the Panasonic Consumer Electronics Company address above.

SERVICE CALLS WHICH DO NOT INVOLVE DEFECTIVE MATERIALS OR WORKMANSHIP AS DETERMINED BY THE WARRANTOR, IN ITS SOLE DISCRETION, ARE NOT COVERED. COSTS OF SUCH SERVICE CALLS ARE THE RESPONSIBILITY OF THE PURCHASER.

warvid 10/20/97

Panasonic Consumer Electronics Company,
Division of Matsushita Electric Corporation of America
One Panasonic way Secaucus,
New Jersey 07094

Panasonic Sales Company,
Division of Matsushita Electric of
Puerto Rico, Inc. ("PSC")
Ave. 65 de Infantería, Km. 9.5
San Gabriel Industrial Park, Carolina,
Puerto Rico 00985

Printed in Japan
VQTS3526B

